



Showcase Processor
Surround
Preamp/Processor

Instructions for Use

Owner's Reference

Showcase Processor

Surround Preamp/Processor

Instructions for Use

v 02.3

CONTACT INFORMATION

Krell Industries, Inc.
45 Connair Road
Orange, CT 06477-3650 USA

TEL 203-799-9954
FAX 203-891-2028
E-MAIL krell@krellonline.com
WEBSITE <http://www.krellonline.com>



This product complies with the EMC directive (89/336/EEC) and the low-voltage directive (73/23/EEC).

WARNINGS

The Showcase Processor must be placed on a firm level surface where it is not exposed to dripping or splashing.

The ventilation grids on the top and bottom of the Showcase Processor must be unobstructed at all times during operation. Do not place flammable material above or beneath the component.

Do not remove or bypass the ground pin on the end of the AC power cord. This could cause radio frequency interference (RFI) to be introduced into your playback system.

Before making connections to the Showcase Processor, make sure the back panel power switch is off. Make sure all cable terminations are of the highest quality and free from frayed ends, short circuits, or cold solder joints.

THERE ARE NO USER SERVICEABLE PARTS INSIDE ANY KRELL PRODUCT.
Please contact your authorized Krell dealer, distributor, or Krell if you have any questions not addressed in this Owner's Reference.

DTS Digital Surround™ is a discrete 5.1 channel digital audio format available on CD, LD, and DVD software which consequently cannot be decoded and played back inside most CD, LD, or DVD players. For this reason, when DTS-encoded software is played back through the analog outputs of the CD, LD, or DVD player, excessive noise will be exhibited. To avoid possible damage to the audio system, proper precautions should be taken by the consumer if the analog outputs are connected directly to an amplification system. To enjoy DTS Digital Surround™ playback, an external 5.1 channel DTS Digital Surround™ decoder system must be connected to the digital output (S/PDIF, AES/EBU, or TosLink) of the CD, LD, or DVD player.

This product is manufactured in the United States of America. Krell® is a registered trademark of Krell Industries, Inc., and is restricted for use by Krell Industries, Inc., its subsidiaries, and authorized agents. Krell Smart System Setup™ is a trademark of Krell Industries, Inc. "DTS", "DTS Digital Surround", "DTS ES Extended Surround", and "Neo:6" are registered trademarks of Digital Theater Systems, Inc. TosLink is a trademark of Toshiba Corporation. Manufactured under license from Dolby Laboratories. "Dolby," "Pro Logic," and the double-D symbol are trademarks of Dolby Laboratories. Confidential Unpublished Works. Copyright 1992–1997 Dolby Laboratories, Inc. All rights reserved. THX is a registered trademark of Lucasfilm, Ltd. Re-Equalization, Timbre Matching, and Decorrelation are trademarks of Lucasfilm, Ltd. All other trademarks and trade names are registered to their respective companies.

Contents

	Page
INTRODUCTION	1
DEFINITION OF TERMS	2
UNPACKING	4
PLACEMENT	5
AC Power Guidelines	5
GETTING STARTED	6
Please Read This First	6
To Select the Initial Video Signal and Format	9
An Introduction to System Setup	10
FRONT PANEL DESCRIPTION	12
BACK PANEL DESCRIPTION	18
REMOTE CONTROL DESCRIPTION	22
Battery Installation and Removal	22
CONNECTING THE SHOWCASE PROCESSOR TO YOUR SYSTEM	27
First: Connect Analog and Digital Sources	27
Next: Connect Video Sources	28
Last: Connect Amplifiers and Sources	28
OVERVIEW: SYSTEM CONFIGURATION AND NAVIGATION	30
Configuration Steps	30
Navigation Conventions	31
SYSTEM CONFIGURATION	32
Accessing the Main Menu	32
Step 1: Configure Loudspeakers	33
Step 2: Listening Room Setup	35
Step 3: Calibrate Volume	36
Step 4: Configure Devices	38
Step 5: Configure Level Adjustment	47
Step 6: Operation	55
SAVING AND RECALLING CUSTOMIZED SETTINGS AND RESTORING THE FACTORY DEFAULT SYSTEM SETTINGS	67
OPERATING THE SHOWCASE PROCESSOR	68
On/Off/Stand-by, Tape Input and Output	68
Simulcast	69
APPENDIX: OPERATING MODES FOR THE SHOWCASE PROCESSOR	70
Automatically Detected Modes	70
User Selectable Modes	71
WARRANTY	74
RETURN AUTHORIZATION PROCEDURE	75
SPECIFICATIONS	76-77

Tables

		Page
TABLE 1	Video Signals and Video Formats Supported by the Showcase Processor	6
TABLE 2	Factory Default Video Inputs and Standards for the Showcase Processor, North American Operation	39
TABLE 3	Factory Default Video Inputs and Standards for the Showcase Processor, International Operation	39
TABLE 4	Factory Default Digital and Analog Inputs for the Showcase Processor, North American and International Operation	41
TABLE 5	Showcase Processor Audio Operating Modes	42
TABLE 6	Krell Music Surround Modes for the Showcase Processor	73

Illustrations

		Page
FIGURE 1	Front Panel Input Device Selection Buttons and Associated Factory Default Video Signals and Video Formats for North American Operation of the Showcase Processor	7
FIGURE 2	Front Panel Input Device Selection Buttons and Associated Factory Default Video Signals and Video Formats for International Operation of the Showcase Processor	8
FIGURE 3	The Showcase Processor Front Panel	11
FIGURE 4	The Showcase Processor Back Panel	17
FIGURE 5	The Showcase Processor Remote Control	21

Introduction

Thank you for your purchase of the Krell Showcase Processor.

The Showcase Processor serves as the centerpiece in a Krell HEAT™—High End Audio Theater—system, which applies the fundamental principles of Krell engineering to the creation of a fully integrated high-performance multichannel sound system. The Showcase Processor delivers unparalleled music and cinema sound-track reproduction through the use of a full complement of advanced Krell technologies including Smart System Setup, discrete Class A, direct-coupled circuitry with balanced outputs, user-configurable input assignment, and broadcast-quality video circuitry.

The Showcase Processor is THX Ultra certified and features THX Surround EX, Dolby Digital 5.1, Dolby Digital EX, DTS-ES 6.1, DTS NEO:6, and Dolby Pro Logic II processing, in addition to nine proprietary Krell Music Surround modes. This flexibility allows upgrades to software via Flash memory for future surround sound formats and design enhancements.

The owner's reference manual contains important information on placement, installation, and operation of the Krell Showcase Processor. Please read this information carefully. A thorough understanding of these details helps ensure satisfactory operation of and long life for your Showcase Processor and related system components.

Definition of Terms

Following are the definitions of key terms used in your owner's reference manual:

INPUT AND OUTPUT CONNECTIONS

Balanced

A symmetrical input or output circuit that has equal impedance from both input terminals to a common ground reference point. The industry standard for professional and sound recording installations, balanced connections have 6 dB more gain than single-ended connections and allow the use of long interconnect cables. Balanced connections are immune to induced noise from the system or the environment.

Single-ended

A two-wire input or output circuit. Use care when using single-ended connections as the ground connection is made last and broken first. Turn the system off prior to making or breaking single-ended connections. Single-ended connections are not recommended for connections requiring long cable runs.

OPERATION

Off

When the power switch on the back panel is placed in the down position and LEDs turn off, the component is off.

Stand-by Mode

When the Showcase Processor is connected to AC power and the back panel power switch is in the up (on) position, the red stand-by LED illuminates. This indicates that the component is in stand-by mode, a low power consumption status that keeps the audio and regulator circuits at idle. Krell recommends leaving the component in the stand-by mode when it is not playing music.

Operational Mode

When the component is in the stand-by mode, and you press the power button on the front panel or the power key on the remote control, the blue power LED illuminates. The component is in the operational mode and is ready to play music.

TECHNOLOGY

Krell HEAT

The Krell term HEAT, or High End Audio Theater, is a design application incorporated into Krell components to enhance multichannel home entertainment systems. A Krell HEAT system is an integrated home theater system consisting of a state-of-the-art Krell preamp/processor and matching amplifiers that reproduce two channel and multichannel sources with audiophile sound quality, placing the audience in the middle of a lifelike environment.

VIDEO

Composite Video

An encoded video signal that transmits luminance (Y) and color (C) information on one wire.

S-Video

Video signal that separately transmits the luminance (Y) and color (C) components of the video signal using one wire.

Component Video

A video signal that uses three wires to convey luminance (Y), red minus luminance (R-Y), and blue minus luminance (B-Y) signals. Component video signals may be interlaced or progressive. Progressive signals build screen content in one pass rather than the two passes required for standard (interlaced) video. Progressive technology eliminates motion artifacts and produces film-quality pictures. Both your source and video monitor must be equipped with progressive video technology to realize this advantage.

YPbPr

One way of designating color difference signals. Y = the luminance signal, Pb = the blue minus luminance (B-Y) signal, and Pr = the red minus luminance (R-Y) signal.

Unpacking

Open the box and remove the top layer of foam. You see these items:

- 1 Showcase Processor
- 1 IEC connector (AC power) cord
- 1 Showcase Processor handheld remote control
- 1 CR2025 lithium battery
- 1 12 VDC output (12 V trigger) cable
- 1 packet containing the owner's reference manual and the warranty registration card.

Carefully remove the Showcase Processor and accessories from the box. Remove the foam end caps and protective plastic wrap from the component.

Note

*If any of these items are not included in the shipping box, please contact your authorized Krell dealer, distributor, or Krell for assistance. Save all packing materials. If you must ship your Showcase Processor in the future, repack the unit in its original packaging to prevent damage in transit. See **Return Authorization Procedure**, on page 75.*

Placement

Before you install the Showcase Processor into your system, review the following guidelines to choose the location for the component. This will facilitate a clean, trouble-free installation.

The Showcase Processor does not require any type of special rack or cabinet for installation. For the dimensions of your Showcase Processor see ***Specifications***, on pages 76-77.

The Showcase Processor requires at least two inches (5 cm) of clearance on each side and at least two inches (5 cm) of clearance above and below the component to provide adequate ventilation. In addition, the Showcase Processor requires at least three inches (7 cm) of clearance between other connected components. For installations inside cabinetry, extra ventilation may be necessary.

AC POWER GUIDELINES

The Showcase Processor has superb regulation and does not require a dedicated AC circuit. Avoid connections through extension cords or multiple AC adapters. High quality 15 amp grounded AC strips are acceptable.

High quality AC line conditioners or filters may be used if they are grounded and meet or exceed the unit's power supply rating of 100 VA. Contact your authorized Krell dealer, distributor, or Krell before using any devices designed to alter or stabilize the AC power for the Showcase Processor.

The Showcase Processor should be used only with the power cord supplied.

Getting Started

PLEASE READ THIS FIRST

The video formats and video signals of the Showcase Processor need to match the video monitor, for the on-screen display (OSD) to be viewable on your video monitor. The format of the video signal can be set to either of two standards: NTSC or PAL. See **Table 1** and **Figures 1 and 2** below.

First match the device with the appropriate factory default to your video monitor's format, NTSC or PAL, and match it to the video signal used to connect the Showcase Processor to your video monitor. The device must be active in order for both the OSD information and the menu to be visible.

North American Example

Select the DVD device to an NTSC video monitor and use the component video output to connect the Showcase Processor to your monitor.

International Example

Select the VCR device to a PAL video monitor and use the S-Video OSD output to connect the Showcase Processor to your monitor.

Table 1 Video Signals and Video Formats Supported by the Showcase Processor

Video Signal	Connector Used	Commonly Labeled	Video Signal
Composite	Single-ended RCA	Video, Composite	NTSC or PAL
S-Video	DIN	S, SV, S-Video	NTSC or PAL
Component	3 Single-ended RCA	Y, Pr, Pb	NTSC or PAL

Figure 1 Front Panel Input Device Selection Buttons and Associated Factory Default Video Signals and Video Formats, for North American Operation of the Showcase Processor

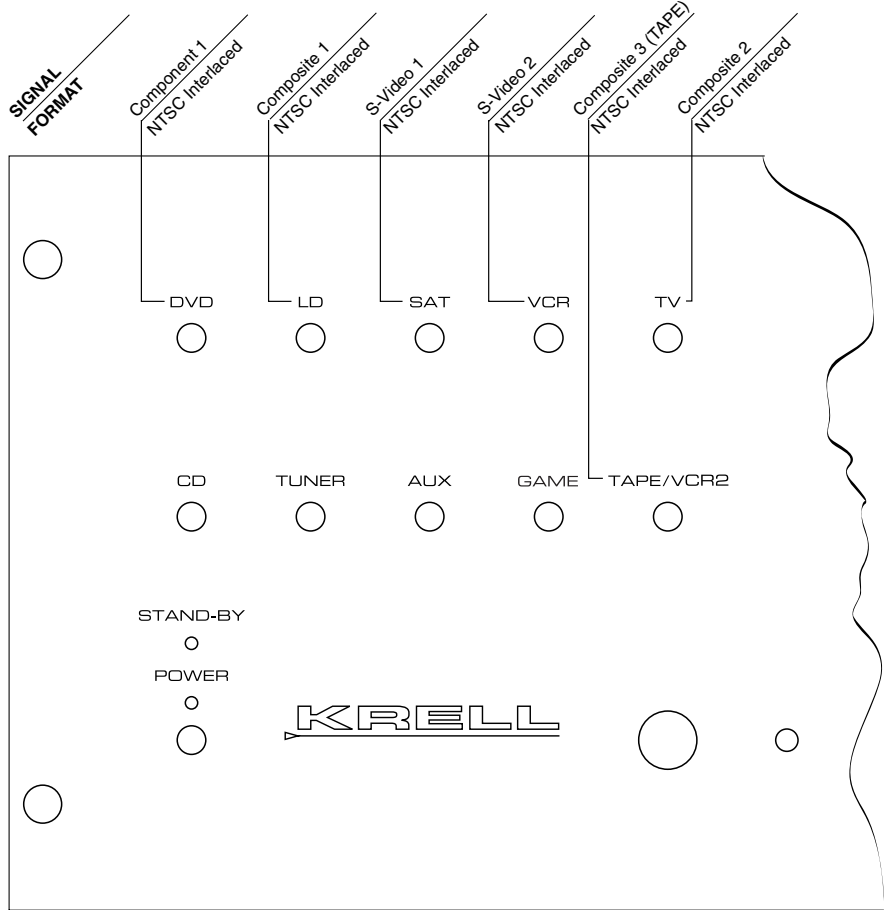

Note
For CD, TUNER, AUX, and GAME, the factory video defaults are disabled and therefore a video format is not available.

Figure 2 Front Panel Input Device Selection Buttons and Associated Factory Default Video Signals and Video Formats, for International Operation of the Showcase Processor

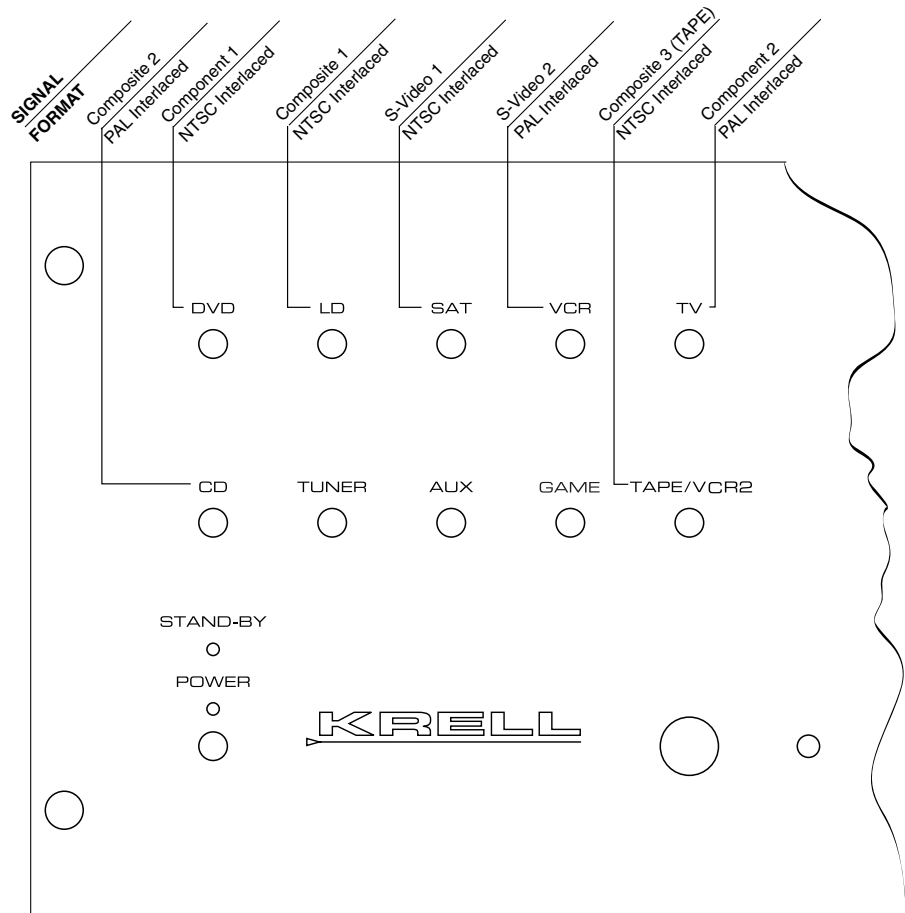

Note
For CD, TUNER, AUX, and GAME, the factory video defaults are disabled and therefore a video format is not available.

TO SELECT THE INITIAL VIDEO SIGNAL AND FORMAT

1. Connect your video monitor to the video output connectors on the Showcase Processor that correspond to the input connectors on your video monitor. See **Table 1**, on page 6.
2. Power on the Showcase Processor by switching the back panel power switch to on. Wait for the Showcase Processor to initialize. Then press the power button on the front panel.
3. Press the front panel input device selection button that matches both the video format and video signal compatible with your connected video monitor. See **Figure 1** for North American operation and **Figure 2** for International operation. This becomes the currently selected video signal output.
4. Verify that the video monitor's video signal input corresponds to the Showcase Processor video signal output. Press the menu key on the remote control to verify that the OSD is now viewable on the video monitor. The system configuration main menu appears when the video format and video signals between the Showcase Processor and your video monitor are compatible.

If you have any questions regarding the selection of the video format, please call your authorized Krell dealer, distributor, or Krell.

AN INTRODUCTION TO SYSTEM SETUP

The Showcase Processor provides a variety of connection and operation options for outstanding music and cinema soundtrack reproduction. To take full advantage of the features the Showcase Processor offers, you'll need to set up your system in this order:

1. Connect your Showcase Processor to the desired analog and digital audio sources, video sources, and amplifiers. See ***Connecting the Showcase Processor to Your System***, on page 27.
2. Configure the loudspeakers, input devices, and trims using the built-in, easy-to-follow system configuration menus. Step-by-step instructions begin on page 32, ***System Configuration***.
3. Review the front panel, back panel, and remote control descriptions for information on input, and mode selections, loudspeaker adjustment, input and output connections for analog, digital, and video sources, and remote control operation. See pages 11-27 for illustrations and descriptions.

After you've connected and configured your Showcase Processor and know its basic features, you're ready to go. See ***Operating the Showcase Processor***, on page 68.

Figure 3 The Showcase Processor Front Panel

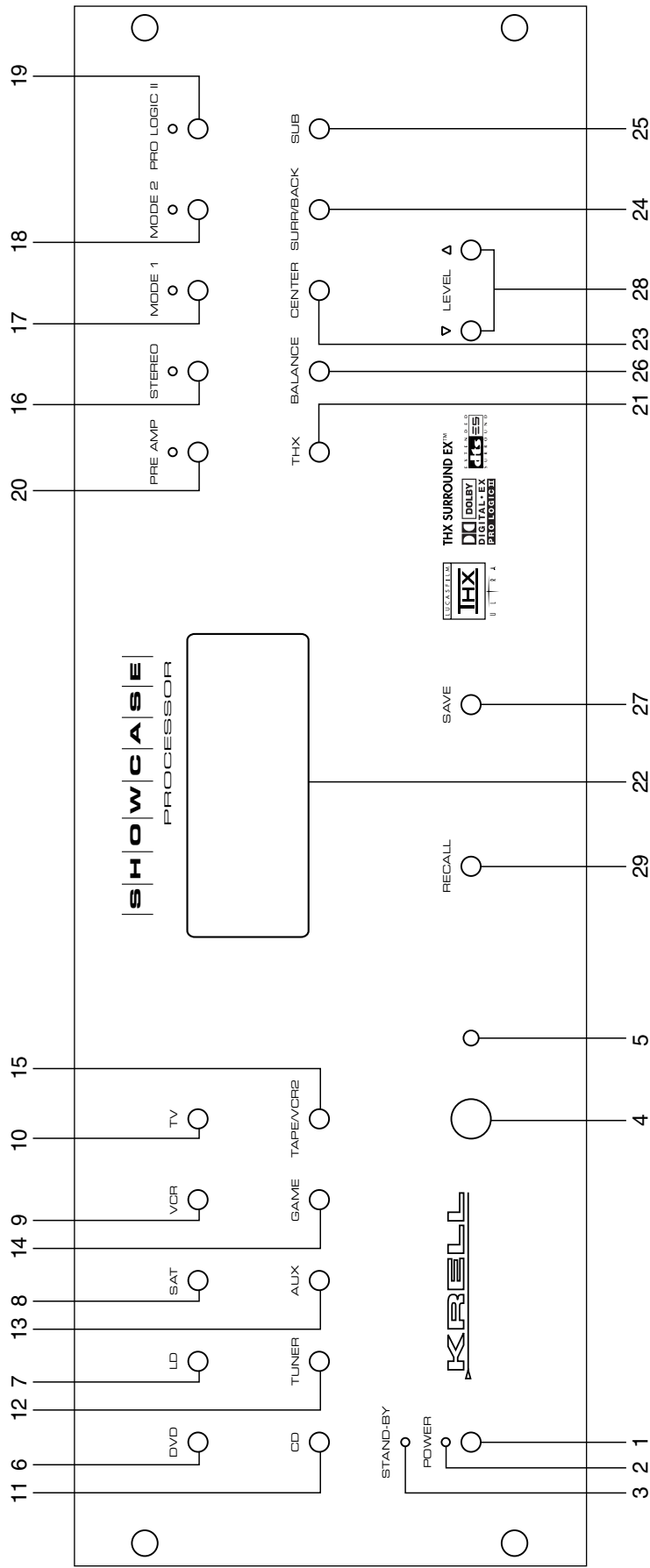

Basic Operation

- 1 Power Button
- 2 Power LED
- 3 Stand-by LED
- 4 Infrared Sensor
- 5 Infrared Emitter

Input Device Selection Buttons

- 6 DVD Button
- 7 LD Button
- 8 SAT Button
- 9 VCR Button
- 10 TV Button

Processing Mode Buttons and LEDs

- 11 CD Button
- 12 Tuner Button
- 13 Aux Button
- 14 Game Button
- 15 Tape/VCR2 Button
- 16 Stereo Button and LED
- 17 Mode 1 Button and LED
- 18 Mode 2 Button and LED
- 19 Pro Logic II Button and LED
- 20 Preamp Button and LED
- 21 THX Button

Display

- 22 Front Panel Display

Individual Channel Trim Buttons

- 23 Center Button
- 24 Surr/Back Button
- 25 Sub Button
- 26 Balance Button

Processor Function Buttons

- 27 Save Button
- 28 Direction or Level Buttons
- 29 Recall Button

Front Panel Description

See Figure 3 on page 11

FEATURES

The Showcase Processor front panel provides power on and off; input, and processing mode selection; monitoring and display of processor status; and balance and volume control. The front panel features are described below:

Basic Operation Buttons

1 Power Button

The power button switches the Showcase Processor from stand-by to the operational mode.

2 Power LED

The blue power LED illuminates when the Showcase Processor is in the operational mode.

3 Stand-by LED

The red stand-by LED illuminates when the back panel power switch (51) is on, indicating that the Showcase Processor is in the stand-by mode. Krell recommends that the back panel power switch remain on at all times.

4 Infrared Sensor

The infrared sensor receives commands from the Showcase Processor remote control. For proper remote control operation, make sure the infrared sensor is not covered or obstructed.

5 Infrared Emitter

Emits the Showcase Processor remote operation code to a learning remote. See *Program Remote*, on page 61.

Input Device Selection Buttons and LEDs

The Showcase Processor is equipped with ten input device selection buttons. If properly configured, the Showcase Processor automatically engages the correct video and audio inputs when you press the device selection button.

6 DVD Button

Use this button to select the digital videodisc device.

7 LD Button

Use this button to select the laser disc device.

8 SAT Button

Use this button to select the satellite feed device.

Front Panel Description, continued

*Input Device Selection
Buttons and LEDs, continued*

9 VCR Button

Use this button to select the VCR device.

10 TV Button

Use this button to select the television device.

11 CD Button

Use this button to select the compact disc device.

12 Tuner Button

Use this button to select the AM/FM tuner device.

13 Aux Button

Use this button to select an auxiliary device, such as phono, tape, or an additional DVD, LD, CD, or VCR.

14 Game Button

Use this button to select a game.

15 Tape/VCR2 Button

Use this button to playback pre-recorded tapes. You may also use this button to compare the output signal of an analog tape recorder to an audio source. See *Tape Input and Output*, on page 68.

**Processing Mode
Buttons and LEDs**

16 Stereo Button and LED

Use this button to select stereo decoding, which allows you to make an A/B comparison or listen to a stereo recording in two channel format (left and right). The red LED illuminates when this feature is engaged.

After you select a mode, press the stereo button once. Press the stereo button again to make the A/B comparison. Press the stereo button again to exit stereo format.

Note

You can make an A/B comparison when you press the stereo button, only if you have selected a previous mode.

17 Mode 1 Button and LED

18 Mode 2 Button and LED

Use these buttons to select available processing modes (such as Dolby Digital, DTS, PLII Movie, THX, etc.) for incoming signals from a video or audio source.

The default mode for a signal is always stored in Mode 1. Use the Mode 1 button to select the default mode. All modes that can be used for the same signal are automatically stored in Mode 2. Use the Mode 2 button to scroll through these other modes. The last mode displayed in Mode 2 is the one selected. Based on the source signal, the Showcase Processor automatically selects the correct modes available for the signal.

19 Pro Logic II Button and LED

Use this button to select the Dolby Pro Logic II modes for Dolby Surround encoded material, including laser discs, videotapes, television broadcasts, and compact discs. The red LED illuminates when Dolby Pro Logic II decoding is selected.

Note

These modes are selected automatically if Dolby Digital source material is encoded for Pro Logic. To turn off these modes, press the Pro Logic II button.

**Processing Mode Buttons
and LEDs, continued**

20 Preamp Button and LED

Use this button to send the signal from an analog input directly to the volume control, with no digital processing, using the analog stage of the preamp. This avoids possible digital signal degradation and can be used for components such as the Krell KPS 28c Compact Disc Player that have a high quality signal. See **Assign Analog Audio Inputs**, on page 43, for information on assigning the analog input to one of the device buttons (DVD, LD, SAT, VCR, TV).

Note

This feature is only available with a signal from an analog input. If you attempt to use it with a signal from a digital input, The Showcase Processor on-screen display will read NOT ALLOWED.

21 THX Button

Use this button to select one of the various THX modes available for the current signal.

Display

22 Front Panel Display

The front panel window provides status messages for Showcase Processor operations, including volume and balance level, decoding mode and zone information. In addition, when a new device is selected, the physical inputs are displayed. The display turns off after 60 seconds of inactivity.

**Individual Channel
Trim Buttons**

Use the center, surr/back, and sub buttons to change taste trims (to make temporary speaker output adjustments) of +/- 10 dB. These temporary changes revert to 0 dB when a new device is selected or when the system is powered down. For more information on taste trims and master (programmable) trims, see **Configure Level Adjustment**, on page 47.

23 Center Button

Press the center button, then use the direction or level buttons (28) to adjust the center loudspeaker volume.

24 Surr/Back Button

Press the surr/back button, then use the direction or level buttons (28) to adjust the volume of the surround loudspeakers. To adjust the back loudspeakers, press the surr/back button. SURROUND TRIM appears on the front panel display. Press the surr/back button again. BACK appears on the front panel display. Then use the direction or level buttons to adjust the volume of the back loudspeakers.

**Individual Channel
Trim Buttons**
continued

25 Sub Button

Press the sub (subwoofer) button, then use the direction or level buttons (28) to adjust the subwoofer loudspeaker volume.

26 Balance Button

Press this button to adjust the main left/right speaker balance. This button converts the volume level controls to balance controls.

Balance levels are shown numerically on the front panel display. Balance may be adjusted in .5 dB increments, up to 6 dB. The center position is displayed as BAL 0. The balance level buttons revert back to their original functions as volume level controls after 3 seconds of inactivity.

**Processor Function
Buttons**

27 Save Button

Press and hold this button to save system configuration settings. The save button is also used in programming a learning remote. See ***Saving and Recalling Customized Settings and Restoring the Factory Default System Settings***, on page 67, and ***Program Remote***, on page 61.

28 Direction or Level Buttons

Use these buttons to scroll through menu selections, adjust the output for the entire system, and adjust balance and volume levels for the center loudspeaker, surround/back loudspeakers, and subwoofer. In the operational mode, right button engages Digital Room EQ and the up and down buttons select EQ memory. Volume and balance levels are shown in the front panel display (22).

29 Recall Button

Use this button to recall previously stored system configuration settings. Also use this button to return configuration settings to factory default: With the Showcase Processor in the operational mode, hold the recall button and press the power button. See ***Saving and Recalling Customized Settings and Restoring the Factory Default System Settings***, on page 67.

Figure 4 The Showcase Processor Back Panel

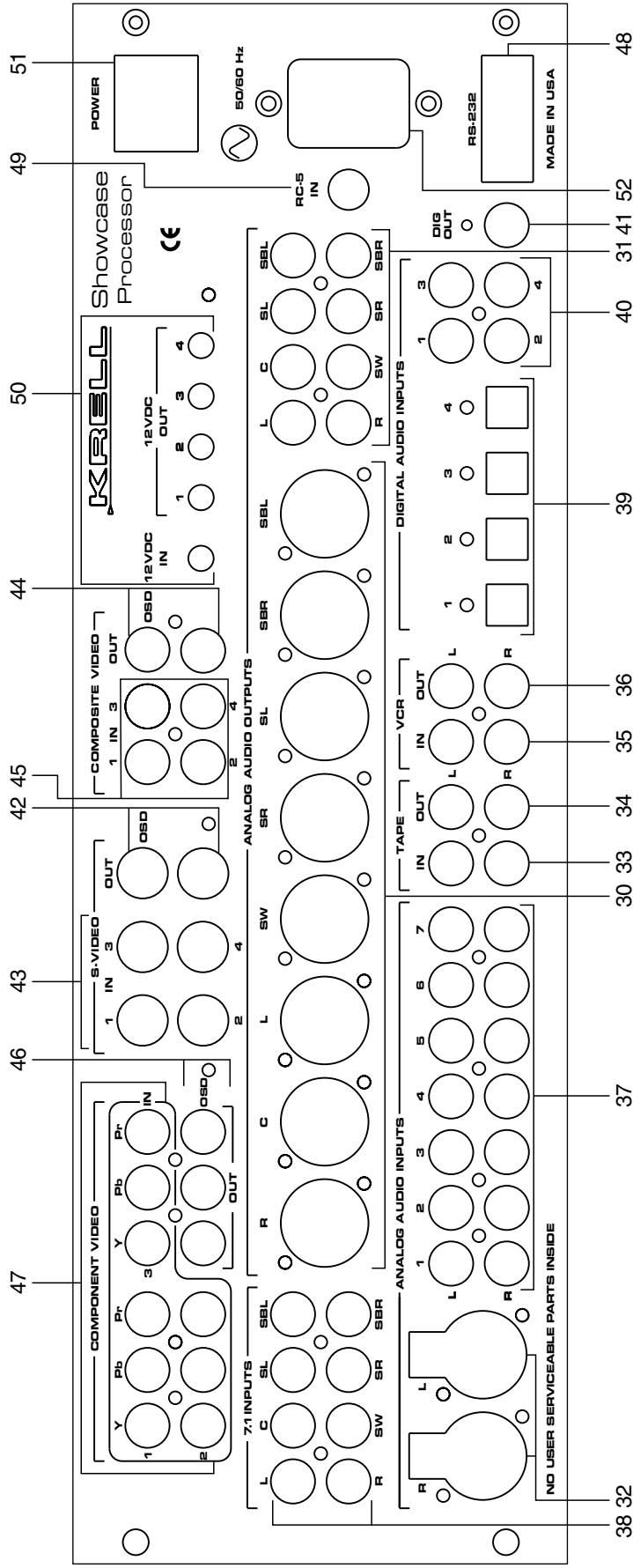

Analog Audio Outputs and Inputs

- 30 Balanced Analog Audio Outputs
- 31 Single-ended Analog Audio Outputs
- 32 Balanced Analog Audio Inputs
- 33 Tape In Left and Right
- 34 Tape Out Left and Right
- 35 VCR In Left and Right
- 36 VCR Out Left and Right
- 37 Single-ended Analog Audio Inputs
- 38 7.1 Audio Inputs

Digital Audio Inputs and Outputs

- 39 Optical Digital Audio Inputs
- 40 Coaxial Digital Audio Inputs
- 41 Digital Audio Outputs

Video Inputs and Outputs

- 42 S-video Outputs
- 43 S-video Inputs
- 44 Composite Video Outputs
- 45 Composite Video Inputs
- 46 Component Video Outputs
- 47 Component Video Inputs

Back Panel Remote Control Connections

- 48 Comm Port RS-232 Remote Connector
- 49 RC-5 In
- 50 12 VDC In and Out

Power Connections

- 51 Back Panel Power Switch
- 52 IEC Connector

Back Panel Description

See Figure 4 on page 17

FEATURES

The back panel of the Showcase Processor provides all audio and video input and output connections, remote control inputs and outputs, power on and off, and power connection. The back panel functions are described below.

Analog Audio Outputs and Inputs

30 Balanced Analog Audio Outputs

The Showcase Processor is equipped with eight balanced analog audio channel outputs, with XLR connectors, for the left, center, subwoofer, surround left, surround right, back left, and back right.

31 Single-ended Analog Audio Outputs

The Showcase Processor is equipped with eight single-ended analog audio channel outputs, with RCA connectors, for the left, center, right, subwoofer, surround left, surround right, back left, and back right.

32 Balanced Analog Audio Inputs

The Showcase Processor is equipped with one set of balanced inputs with XLR connectors.

33 Tape In Left and Right

The Showcase Processor is equipped with one set of single-ended tape inputs with RCA connectors.

34 Tape Out Left and Right

The Showcase Processor is equipped with one set of single-ended tape outputs with RCA connectors.

35 VCR In Left and Right

The Showcase Processor is equipped with one set of single-ended inputs with RCA connectors, for a VCR audio source.

36 VCR Out Left and Right

The Showcase Processor is equipped with one set of single-ended outputs with RCA connectors, for a VCR audio source.

37 Single-ended Analog Audio Inputs

The Showcase Processor is equipped with seven sets of single-ended inputs with RCA connectors.

38 7.1 Audio Inputs

The Showcase Processor is equipped with eight single-ended 7.1 inputs for multichannel SACD and DVD audio devices. These inputs are analog pass-through inputs.

Digital Audio Inputs and Outputs

39 Optical Digital Audio Inputs

The Showcase Processor is equipped with four optical digital EIAJ inputs with TosLink connectors.

40 Coaxial Digital Audio Inputs

The Showcase Processor is equipped with four coaxial digital audio inputs with RCA connectors.

41 Digital Audio Outputs

The Showcase Processor is equipped with two digital audio outputs: one coaxial with an RCA connector.

Video Inputs and Outputs

42 S-video Outputs

The Showcase Processor is equipped with two S-video outputs with DIN connectors. The main S-video output (labeled OSD on back panel) includes on-screen display. For dubbing purposes, the second S-video output does not include on-screen display.

43 S-video Inputs

The Showcase Processor is equipped with four S-video inputs with DIN connectors.

44 Composite Video Outputs

The Showcase Processor is equipped with two composite video outputs with RCA connectors. The main composite video output (labeled OSD on back panel) includes on-screen display. For dubbing purposes, the second composite video output does not include on-screen display.

45 Composite Video Inputs

The Showcase Processor is equipped with four RCA composite video inputs with RCA connectors.

46 Component Video Outputs

The Showcase Processor is equipped with one set of component video outputs with RCA connectors. Component video uses three wires, labeled Y, Pr, and Pb on the back panel, to convey the video signal. These inputs are compatible with all wideband video sources. See *Configure Devices*, on page 38.

Back Panel Description, continued

Video Inputs and Outputs,
continued

47 Component Video Inputs

The Showcase Processor is equipped with three sets of component video inputs.

Note

On-screen display (OSD) is not available for progressive component video. OSD is available for interlaced component video.

**Back Panel Remote
Control Connections**

48 Comm Port RS-232 Connector

The Showcase Processor is equipped with an RS-232 communication port, which allows you to send operational instructions directly to the Showcase Processor using an external computer control system.

49 RC-5 In

The RC-5 input makes custom installation easy and secure by accepting baseband RC-5 input commands from hardwired remote controllers.

50 12 VDC In and Out

The 12 VDC output sends a 12 Volt power on/off signal to other Krell components via a 12 V trigger cable, as well as to other devices that incorporate 12 Volt power on/off trigger input. The Showcase Processor has four programmable 12 Volt outputs and one input.

Note

When the Showcase Processor is in the operational mode and a trigger is enabled, the 12 VDC Out provides 12 V of DC output. When the Showcase Processor is in the stand-by mode or off, or if a trigger is not enabled, the DC output is 0 V.

Power Connections

51 Back Panel Power Switch

Use this switch to change the Showcase Processor from off to stand-by.

52 IEC Connector

The Showcase Processor is equipped with a standard female IEC power connector, for use with the AC power cord.

Figure 5 The Showcase Processor Remote Control

Power Keys

- 53 Amp Key
- 54 Pre Key (Power Pre Key)

Device Selection Keys

- 55 DVD Key
- 56 LD Key
- 57 SAT Key
- 58 TV Key
- 59 CD Key
- 60 Tuner Key
- 61 Aux Key
- 62 Aux 2 Key (Game Key)
- 63 VCR Key
- 64 Tape Key

Processing Mode Keys

- 65 Stereo Key
- 66 M1 Key (Mode 1 Key)
- 67 M2 Key (Mode 2 Key)
- 68 Pro Logic II Key
- 69 Pre Key (Preamp Pre Key)

Control Function Keys

- 70 Bal Key (Balance Key)
- 71 Cntr Key
- 72 Surr/Back Key
- 73 Sub Key
- 74 Prev Key
- 75 Direction or Level Keys
- 76 Menu Key
- 77 Mute Key
- 78 Enter Key
- 79 THX Key

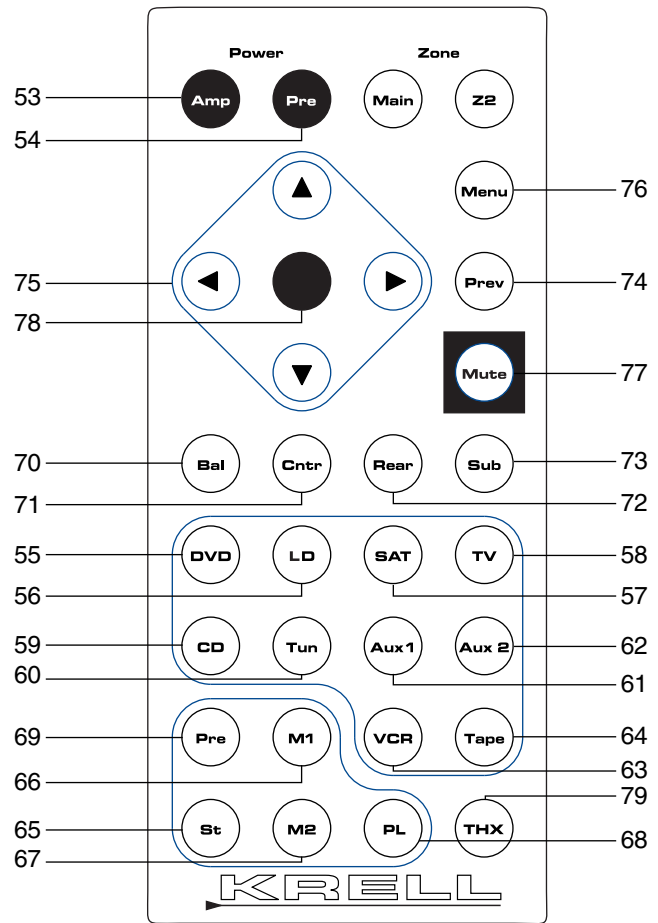

Remote Control Description

See Figure 5 on page 21

The Showcase Processor remote control provides on and off, input selection, processing mode selection, speaker volume and balance adjust, and mute functions, as well as access to the system configuration menu.

BATTERY INSTALLATION AND REMOVAL

The Showcase Processor remote control uses one CR2025 lithium battery, which is included with the shipment.

To open the battery compartment on the back of the remote control:

1. Place the remote face down on the table.
2. Use your thumbnail or a small jeweler's or eyeglass screwdriver to move the small tab toward the center of the remote, while using your index fingernail or screwdriver to pull down gently on the slot to the right of the tab. The battery compartment will slide out.
3. Place the battery, plus side up, in the battery tray.
4. Slide battery compartment back into the remote until you hear a click.

The remote control is ready for operation.

Notes

Do not use a knife or other sharp objects to open the battery compartment; they will scratch the remote control finish.

Replace batteries when remote control function becomes intermittent.

Remove batteries if the remote control is not to be used for a long period of time. Battery leakage can damage the remote control.

FEATURES

Showcase Processor remote control keys and their functions are described below:

Power Keys

53 Amp Key

Use this key to power on/off a Krell remote control amplifier.

54 Pre Key (Power Pre Key)

Use this key to switch the Showcase Processor between the stand-by mode and the operational mode.

Device Selection Keys

55 DVD Key

Use this key to select the digital videodisc device.

56 LD Key

Use this key to select the laser disc device.

57 SAT Key

Use this key to select the satellite source device.

58 TV Key

Use this key to select the television device.

59 CD Key

Use this key to select the compact disc device.

60 Tuner Key

Use this key to select the AM/FM tuner device.

61 Aux Key

Use this key to select the auxiliary device, such as phono, tape, or an additional DVD, LD, CD, or VCR.

62 Aux 2 Key (Game Key)

Use this key to select a game.

63 VCR Key

Use this key to select the VCR device.

64 Tape Key

Use this key to select the output from an analog tape recorder connected to the tape inputs.

Processing Mode Keys

65 Stereo Key

Use this key to select stereo decoding, which allows you to make an A/B comparison or listen to a stereo recording in two channel format (left and right). The red LED illuminates when this feature is engaged.

After you select a mode, press the stereo button once. Press the stereo button again to make the A/B comparison. Press the stereo button again to exit stereo format.

Note

You can make an A/B comparison when you press the stereo button, only if you have selected a previous mode.

66 M1 Key (Mode 1 Key)

67 M2 Key (Mode 2 Key)

Use these keys to select available processing modes (such as Dolby Digital, DTS, PLII Movie, THX, etc.) for incoming signals from a video or audio source.

The default mode for a signal is always stored in Mode 1. Use the Mode 1 key to select the default mode. All other modes that can be used for the same signal are automatically stored in Mode 2. Use the Mode 2 key to scroll through these other modes. The last mode displayed in Mode 2 is the one selected. Based on the source signal, the Showcase Processor automatically selects the correct modes available for the signal.

68 Pro Logic II Key

Use this button to select the available Dolby Pro Logic II modes for Dolby Surround encoded material, including laser discs, videotapes, television broadcasts, and compact discs. The red LED illuminates when the Showcase Processor is in the Dolby Pro Logic II decoding mode.

Note

This mode is selected automatically if Dolby Digital source material is encoded for Pro Logic. To turn off this mode, press the Pro Logic II key.

*Processing Mode Keys,
continued*

69 Pre Key (Preamp Pre Key)

Use this button to send the signal from the analog input directly to the volume control, with no digital processing, using the analog stage of the preamp. This avoids possible digital signal degradation and can be used for components such as the Krell KPS 28c Compact Disc Player that have a high quality signal. See **Assign Analog Audio Inputs**, on page 43, for information on assigning the analog input to one of the device buttons (DVD, LD, SAT, VCR, TV).

Note

This feature is only available with a signal from an analog input. If you attempt to use it with a signal from a digital input, the Showcase Processor on-screen display will read NOT ALLOWED.

Control Function Keys

70 Bal Key (Balance Key)

Press and hold this key to convert the volume level controls to balance controls. See **Balance Button (26)**, on page 16.

Note

*Use the center, surr/back, and sub keys to change taste trims (to make temporary loudspeaker output adjustments) of +/- 10 dB. These temporary changes revert to 0 dB when a new device is selected or the system is powered down. For more information on taste trims and master (programmable) trims, see **Configure Level Adjustment**, on page 47.*

71 Cntr Key

Use this key to select the center loudspeaker, then use the direction keys (75) to adjust volume.

72 Surr/Back Key

Use this key to select the surround and/or back loudspeakers, then use the direction keys (75) to adjust the volume of the surround loudspeakers. To adjust the back loudspeakers, press the surr/back button. SURROUND TRIM appears on the front panel display (23). Press the surr/back button again. SURR/BACK appears on the front panel display. Then use the direction keys (75) to adjust the volume of the back loudspeakers.

73 Sub Key

Use this key to select the subwoofer, then use the direction keys (75) to adjust volume.

Remote Control Description, continued

Control Function Keys,
continued

74 Prev Key

Use this key to escape from a system configuration on-screen menu to the previously displayed screen.

75 Direction or Level Keys

Use these keys to scroll through menu selections, adjust the output for the entire system, and adjust balance and volume levels for the center loudspeaker, surround/back loudspeakers, and subwoofer. Volume and balance levels are shown in the front panel display (23).

76 Menu Key

Use this key to access the system configuration on-screen menus.

77 Mute Key

Use this key to mute the output of the Showcase Processor. VOLUME MUTE appears in the front panel display (23).

78 Enter Key

Use this key to accept configuration menu selections, accept an input device selection, or to display current system conditions.

79 THX Key

Use this key to select of the various THX modes available for the current signal.

Connecting the Showcase Processor to Your System

This section provides information about connecting the Showcase Processor to analog and digital sources, video sources, and amplifiers. The Showcase Processor is equipped with balanced and single-ended inputs.

Krell recommends using balanced interconnect cables. Balanced interconnect cables not only can minimize sonic loss but also are immune to induced noise, especially for installations using long cables. Balanced connections have 6 dB more gain than single-ended connections. When level matching is critical, keep this specification in mind. Krell recommends that you use balanced inputs for components that will use the preamp mode.

FOLLOW THESE CONNECTION STEPS

First: Connect Analog and Digital Sources

Follow these steps to connect the Showcase Processor to your system:

1. Make sure all power sources and components are off before connecting inputs and outputs.
2. Neatly arrange and organize wiring to and from the Showcase Processor and all components. Separate AC wires from audio cables to prevent hum or other unwanted noise from being introduced into the system.
3. For stereo analog input sources, connect the right and left outputs of your source components to the inputs on the Showcase Processor. The Showcase Processor is equipped with nine sets of single-ended analog audio inputs (37) (S-1 through S-7, tape, and VCR) via RCA connectors and one set of balanced analog audio inputs (32) via XLR connectors.

For multichannel analog sources (for example, multichannel SACD and DVD audio players), connect the outputs of your source component to the 7.1 inputs (38) on the back panel.

4. For digital audio sources, connect the digital audio output of your source components to the digital inputs on the Showcase Processor. The Showcase Processor is equipped with four coaxial digital audio inputs (40) via RCA connectors and four digital EIAJ optical inputs (39) via TosLink connectors.

Note

See **Please Read This First**, on page 6, for information on making the on-screen display visible on your video monitor.

**Next:
Connect Video
Sources**

1. Connect the video source outputs to the appropriate video inputs on the Showcase Processor.
2. Connect the video outputs of the Showcase Processor to the inputs of your video monitor and/or video recorder.

Component video signals use three wires that convey luminance (Y), red minus luminance [R – Y] (Pr), and blue minus luminance [B – Y] (Pb) signals.

Use the component connection when the source device (DVD) and output device (TV) both feature component connections. See the user manuals included with these devices for more information.

The Showcase Processor is also equipped with four S-video inputs (43) and four composite video inputs (45). S-video cables transmit the color and luminance components of the video signal separately.

The Showcase Processor is equipped with two S-video outputs (42), two composite video outputs (44), and one set of component video outputs. One S-video output, one composite video output, and the component video output include on-screen display (OSD). For dubbing purposes, only the S-video and composite outputs labeled OSD display on screen information.

Note

S-video inputs can be seen only on S-video outputs. The same is true for composite and component video signals.

**Last:
Connect Amplifiers
and Sources**

The Showcase Processor has balanced outputs with XLR connectors and single-ended outputs with RCA connectors. Both outputs are active at all times, allowing simultaneous connection to separate amplifiers. Only one of these output formats should be connected to a single amplifier.

1. Connect the outputs of the Showcase Processor to the input(s) of your power amplifier(s).
2. Connect source devices to the appropriate inputs on the back panel.
3. Connect the AC power cord to the IEC connector (52) on the Showcase Processor and to the AC wall receptacle.

Connecting the Showcase Processor to Your System, continued

Last:
Connect Amplifiers
and Sources, continued

4. Move the back panel power switch (51) into the up (on) position. The red power LED on the front panel illuminates. The words PLEASE WAIT, INITIALIZING appear in the front panel display (25). When the initializing message disappears, the Showcase Processor is ready to switch to the operational mode.
5. Use either the front panel power button (1) or the remote control power pre key (54) to power on the Showcase Processor. The blue power LED (2) on the front panel illuminates. The Showcase Processor is now in the operational mode and ready to be configured.

IMPORTANT

Make sure that any source devices are off when you configure the Showcase Processor.

Overview: System Configuration and Navigation

This section briefly outlines the configuration menus and introduces you to the navigational features of the menus.

CONFIGURATION STEPS

For best results, follow these steps

The easy-to-follow, step-by-step configuration menus let you set up your Showcase Processor for optimum performance. Detailed instructions begin on page 32. Krell recommends that you configure your component in the following order:

1. CONFIGURE SPEAKERS

The configure speaker menu lets you tell the Showcase Processor how many and what type of loudspeakers are in your system and allows you to select the bass range for each loudspeaker. It also allows you to control the subwoofer output and set the crossover frequency.

2. LISTENING ROOM SETUP

The listening room setup menu lets you define the exact location of each loudspeaker in the system, so that the Showcase Processor can synchronize the output to all speakers, no matter where they are located in the room.

3. CALIBRATE VOLUME

The calibrate volume menu lets you set the volume to a reference level, to match the sensitivities of different loudspeakers and amplifiers in your system.

4. CONFIGURE DEVICES

The configure devices menu lets you assign each device's inputs and configure modes and triggers.

5. CONFIGURE LEVEL ADJUSTMENT

The configure level menu lets you set master volume trims for the components in your system. These fixed positive or negative volume offsets let you maintain level matching while switching between inputs with different output levels.

6. OPERATION

The operation menu lets you select screen background color, position and display time for on-screen display, set audio operation, program a learning remote control, and adjust frequency response using the Krell Digital Room Equalizer.

NAVIGATION CONVENTIONS

The remote control is the main input device for configuring the Showcase Processor. For all system options, use the following keys to navigate through the configuration menu screens:

82 Menu Key

Press this key once to enter the configuration menu. The front panel display reads MENU MODE. The MAIN MENU screen appears.

Press this key again to exit the configuration menu. The Showcase Processor reverts to the operational mode.

81 Direction or Level Keys

Press these keys to scroll line by line through options on a menu screen. After pressing enter (84), press the direction or level key again to scroll through options within a single line.

84 Enter Key

Press this key once to select a highlighted item. Once an item is selected, use the direction or level keys (81) to scroll through available options within a line. To select a highlighted option within a line, press the enter key again.

80 Prev Key

Press this key once to return to the previous screen within the configuration menu.

54 Pre Key (Power Pre Key)

Press this key once to exit the configuration menu. The Showcase Processor reverts to the stand-by mode.

To Select and Enter Menu Items

When a menu screen first appears, and there is a cursor blinking at one menu item, press the enter key (75) to select the menu item. If the item is configurable, the entire selection blinks along with the cursor.

Then use the direction keys (75) to scroll through the options that are blinking. Press the enter key to set your selection. After you have set the selection, the selection stops blinking and only the cursor at the menu item is blinking. Use the direction keys to move the cursor to the next menu item.

System Configuration

The Showcase Processor is shipped with factory default selections in the configuration menus. For correct operation and maximum performance, the Showcase Processor needs to be configured for each system device, its capabilities, and loudspeaker positions in the listening room.

To save your new configuration menus, or revert to the factory defaults, see ***Saving and Recalling Customized Settings, and Restoring the Factory System Settings***, on page 67.

Krell recommends configuring your system step-by-step, in the sequence described below. Enter information into the Showcase Processor through the interactive on-screen menus. These menus are structured to guide you through the setup process for each device, or for your entire surround sound system.

ACCESSING THE MAIN MENU

Press the menu key. The front panel display reads MENU MODE. The MAIN MENU screen appears.

Main Menu Screen

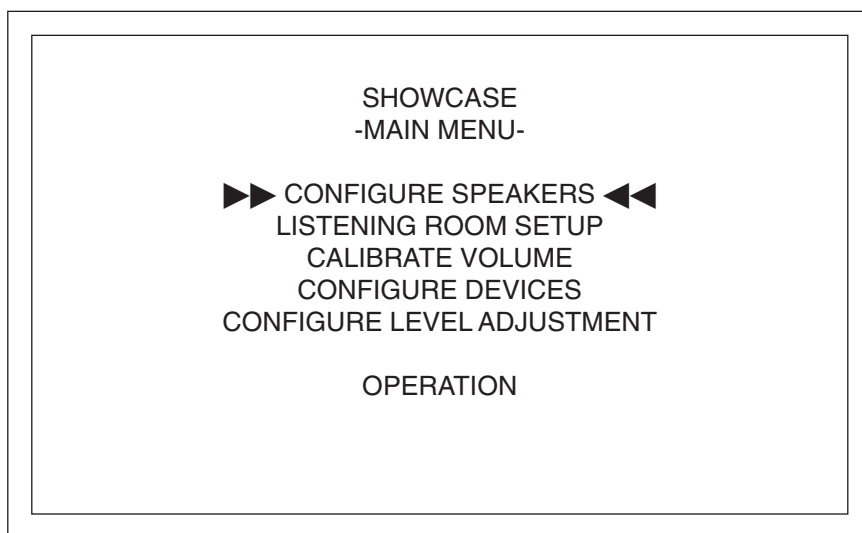

How To Navigate the Menu and Make a Selection

1. Use the direction keys to scroll from line to line.
2. Press enter to select a line.
3. Use the direction keys to scroll through options within a line.
4. Press enter to select and set an option.
5. Use the direction keys to scroll to the next line.

**STEP 1
CONFIGURE
LOUDSPEAKERS**

The first option on the main menu screen, CONFIGURE SPEAKERS, lets you tell the Showcase Processor how many and what type of loudspeakers are in your system and select the bass range for each loudspeaker. It also allows you to control the subwoofer output and set the crossover frequency.

Select CONFIGURE SPEAKERS on the MAIN MENU. The SPEAKER SETUP screen appears.

Speaker Setup Screen

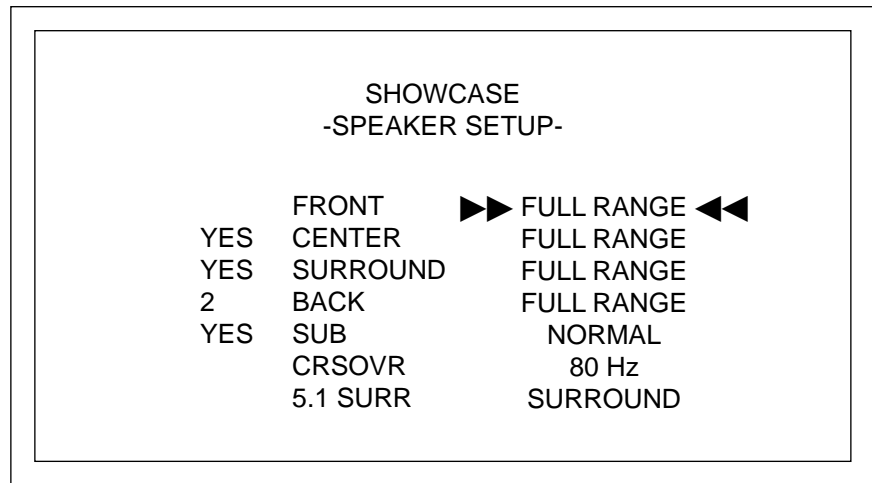

If you have a 5.1 system, select no back speakers. If you have a 6.1 system, select 1 back speaker. If you have a 7.1 system, select 2 back speakers.

Note

When 1 back speaker is selected, the signal is present at the left back output.

System Configuration, continued

Speaker Setup Screen, continued

Using this screen, you can enable loudspeakers that are in your system in the left column and select loudspeaker characteristics in the far right column.

FULL RANGE

FULL RANGE sends 20Hz to 20KHz signals to the loudspeaker. LIMITED sends information from the crossover frequency (see below) to 20KHz to the loudspeaker. The frequencies below the crossover frequency are sent to the subwoofer if present; otherwise, these low frequencies are sent to the full range loudspeakers in the system.

SUB

Select NORMAL or ENHANCED to choose the amount of bass information sent to the subwoofer. NORMAL sends the low frequencies from the limited speakers and the .1 (or LFE) signal to the subwoofer.

ENHANCED sends additional bass information from the left and right loudspeakers to the subwoofer in addition to the low frequencies from the limited loudspeakers and the .1 (or LFE) signal.

CRSOVR

Crossover selections are 120, 100, 80, 60, and 40 Hz. The standard crossover setting is 80 Hz. Choose the crossover frequency appropriate for your loudspeakers. The frequencies below the crossover frequency are sent to the subwoofer if a subwoofer is present; otherwise, these low frequencies are sent to the full range loudspeakers in the system.

5.1 SURR

Select SURROUND, BACK, or BOTH to choose which loudspeakers in a 6.1 or 7.1 system receive surround information when playing a Dolby Digital 5.1 or DTS 5.1 encoded software. SURROUND sends surround channel information to your surround loudspeakers only. BACK sends surround channel information to your back loudspeakers only. BOTH sends surround channel information to your surround and back loudspeakers simultaneously.

How To Navigate the Menu and Make a Selection

1. Use the direction keys to scroll from line to line.
2. Press enter to select a line.
3. Use the direction keys to scroll through options within a line.
4. Press enter to select and set an option.
5. Use the direction keys to scroll to the next line.

After selecting the appropriate loudspeaker configuration for your system, press the previous key (74) twice to return to the main menu.

STEP 2
LISTENING ROOM
SETUP

The second option on the main menu screen, ROOM SETUP, allows you to tell the Showcase Processor the exact location of each loudspeaker in your system.

Select LISTENING ROOM SETUP on the MAIN MENU. The ROOM SETUP screen appears:

Room Setup Screen

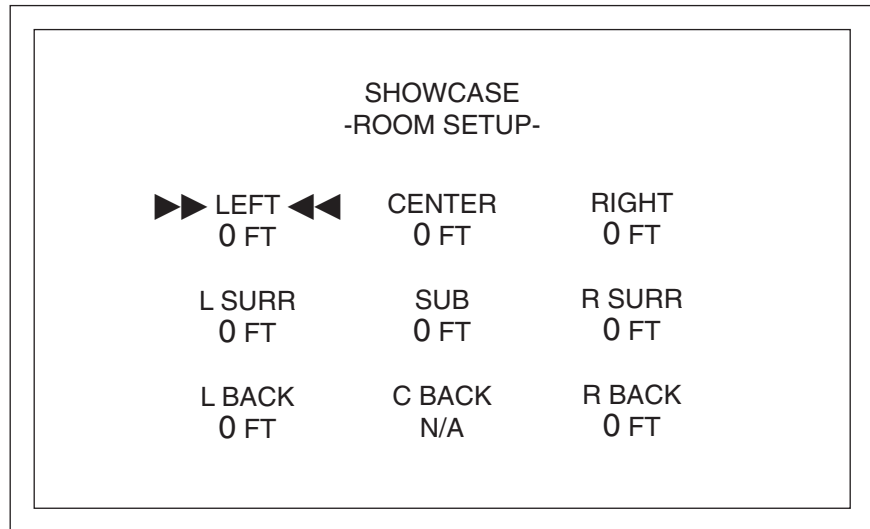

When you access the ROOM SETUP screen, the cursor is blinking at the LEFT loudspeaker. Use the direction and enter keys to navigate the screen, select loudspeakers, and enter the correct distance (0 to 30 feet) from the main listening position to the loudspeaker. After all the distances are set, press the previous key twice to return to the main menu.

Note

Any speaker not configured in the SPEAKER SETUP menu displays N/A (not available) on the ROOM SETUP screen.

**STEP 3
CALIBRATE VOLUME**

The third option on the main menu screen, CALIBRATE VOLUME, allows you to calibrate each channel using the internal noise generator of the Showcase Processor.

Note

A sound pressure level (SPL) meter is required for this procedure.

Select CALIBRATE VOLUME on the MAIN MENU. The CALIBRATE ROOM SETUP screen appears:

Calibrate Room Setup Screen

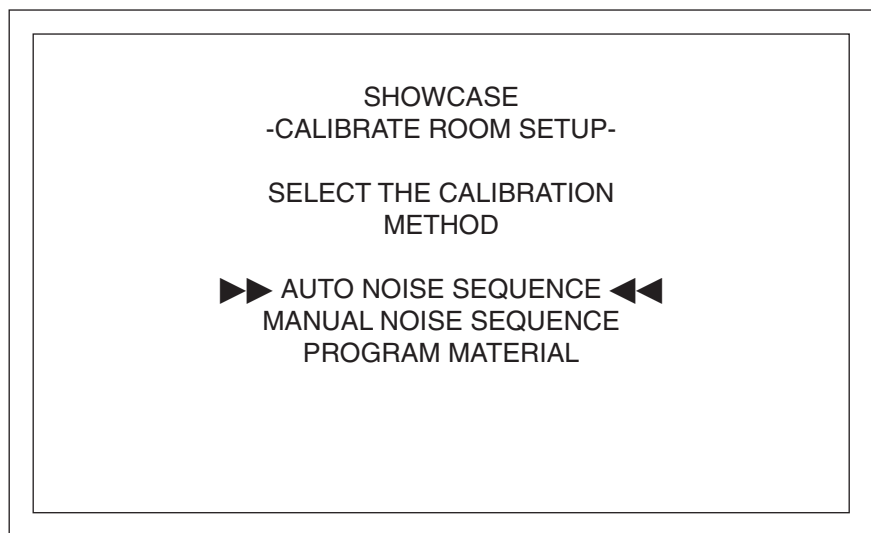

Auto Noise Sequence

Press the enter key to choose AUTO NOISE SEQUENCE. The AUTO CALIBRATION screen appears:

Auto Calibration Screen

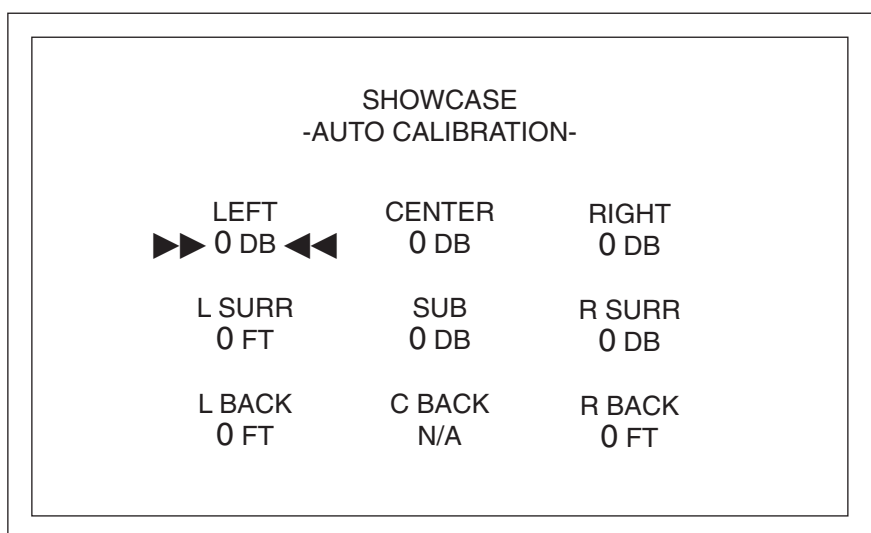

How To Navigate the Menu and Make a Selection

1. Use the direction keys to scroll from line to line.
2. Press enter to select a line.
3. Use the direction keys to scroll through options within a line.
4. Press enter to select and set an option.
5. Use the direction keys to scroll to the next line.

System Configuration, continued

STEP 3
CALIBRATE VOLUME

continued

Set the SPL meter to C weighting and slow response. After initializing, the LEFT channel dB setting on the screen blinks, and you hear band limited white noise through the left loudspeaker. This noise continues for two seconds and then moves clockwise to the next loudspeaker in the system.

While the individual channel on screen is blinking, use the direction keys to adjust each loudspeaker's setting until the SPL meter reads 75 dB.

Repeat this process with the remaining loudspeakers. When all the loudspeakers are adjusted, press the previous key twice to return to the main menu screen.

Note

The adjustments must be made while the channel on screen is blinking.

Manual Noise Sequence

Set the SPL meter to C weighting and slow response. After initializing, the cursor at the LEFT channel dB setting on the screen blinks. Press enter. You hear banded white noise through the left loudspeaker.

While the individual channel on screen is blinking, use the direction keys to adjust each loudspeaker's setting until the SPL meter reads 75 dB.

Press enter to set each selection, then use the direction keys to move to the next loudspeaker.

Repeat this process for all loudspeakers. Press the previous key twice to return to the main menu screen.

Note

Any speaker not configured in the SPEAKER SETUP menu displays N/A (not available) for the dB specification.

Program Material Option

The program material option uses the same screen as the automatic or manual noise sequence, but requires external program material such as a test disc. The source plays, simultaneously, from all configured loudspeakers. Use the enter and direction keys to individually adjust loudspeaker levels based on your listening preferences rather than SPL readings. If all channels are not present in the source material, they will not be heard during this process.

**Please read
before continuing
on to Step 4**

To help you understand the numerous configuration options available through the Showcase Processor, Step 4 illustrates configuring a specific source device: a DVD player.

To configure other source devices, Krell recommends that you configure one device at a time, using the menu's step-by-step format.

IMPORTANT

Some Showcase Processor configurations are designed for digital only, and some are designed for analog only. If you try to format an analog source device using a digital configuration, the menu will not let you proceed.

**STEP 4
CONFIGURE DEVICES**

The fourth option on the main menu screen, CONFIGURE DEVICES, allows you to assign video and audio inputs to source devices and configure triggers for devices in the system.

Select CONFIGURE DEVICES on the MAIN MENU. The CONFIGURE DEVICES screen appears:

Configure Devices Screen

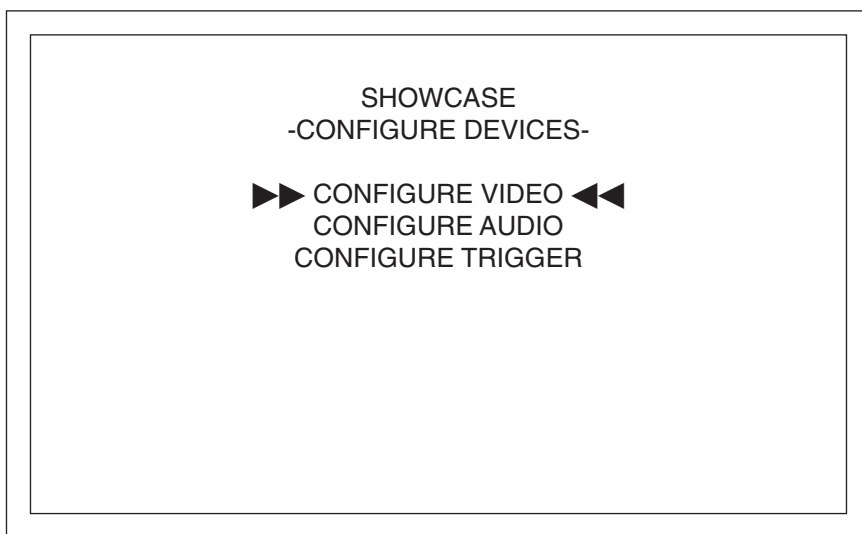

**How To Navigate the Menu
and Make a Selection**

1. Use the direction keys to scroll from line to line.
2. Press enter to select a line.
3. Use the direction keys to scroll through options within a line.
4. Press enter to select and set an option.
5. Use the direction keys to scroll to the next line.

**Please read
before assigning
video inputs**

The Showcase Processor is shipped with separate factory default video inputs and standards for North American and international operation. See **Table 2** and **Table 3** below.

Table 2 Factory Default Video Inputs and Standards for the Showcase Processor, North American Operation

Device	Assigned Input	Video Standard
DVD	Component 1	NTSC Interlaced
LD	Composite 1	NTSC Interlaced
SAT	S-Video 1	NTSC Interlaced
VCR	S-Video 2	NTSC Interlaced
TV	Composite 2	NTSC Interlaced
CD	Disabled	N/A
Tuner	Disabled	N/A
Aux 1	Disabled	N/A
Aux 2 (Game)	Component 2	NTSC Interlaced
Tape	Composite 3	NTSC Interlaced

Table 3 Factory Default Video Inputs and Standards for the Showcase Processor, International Operation

Device	Assigned Input	Video Standard
DVD	Component 1	NTSC Interlaced
LD	Composite 1	NTSC Interlaced
SAT	S-Video 1	NTSC Interlaced
VCR	S-Video 2	PAL Interlaced
TV	Component 2	PAL Interlaced
CD	Composite 2	PAL Interlaced
Tuner	Disabled	N/A
Aux 1	Disabled	N/A
Aux 2 (Game)	Component 2	NTSC Interlaced
Tape	Composite 3	NTSC Interlaced

Note

Video factory defaults for the Showcase Processor do not need to be changed if your system matches the factory defaults.

Assign Video Input

Select CONFIGURE VIDEO from the CONFIGURE DEVICES menu. The ASSIGN VIDEO INPUT screen appears:

Assign Video Input Screen

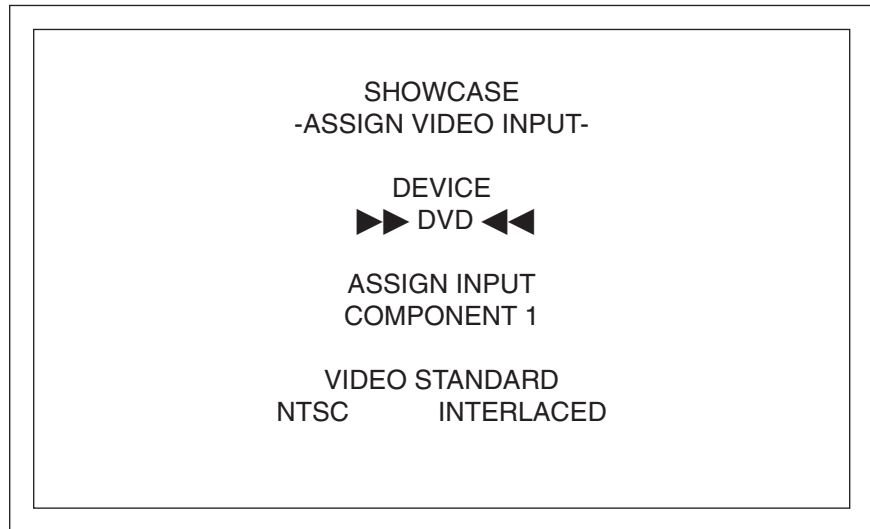

The ASSIGN VIDEO INPUT screen lets you select the device to configure and assign an input to the device. Assigned inputs correspond to the inputs on the back panel. For devices that do not use a video input, for example, a CD player, there are two options: PREVIOUS or DISABLED. PREVIOUS allows the last active video input to continue to be displayed, as long as a previous selection has been made. DISABLED turns off the video outputs.

You may also choose a standard video format, either NTSC or PAL, and select whether the component signals are INTERLACED or PROGRESSIVE/HD, depending upon your video source and monitor capabilities.

Use the direction and enter keys (75) to navigate the menu and set selections. When all selections are entered, press the previous key (74) once to return to the CONFIGURE DEVICES menu.

How To Navigate the Menu and Make a Selection

1. Use the direction keys to scroll from line to line.
2. Press enter to select a line.
3. Use the direction keys to scroll through options within a line.
4. Press enter to select and set an option.
5. Use the direction keys to scroll to the next line.

System Configuration, continued

Please read before configuring audio and digital inputs

The Showcase Processor is shipped with factory defaults for analog and digital inputs. These defaults are the same for domestic and international operation, and are listed in **Table 4** below:

Table 4 Factory Default Digital and Analog Audio Inputs for the Showcase Processor, North American and International Operation

Device	Assigned Input		Configuration Options				
	Digital	Analog	Digital				Analog
			Dolby Digital 2.0	Dolby Digital 5.1	DTS 5.1	PCM	
DVD	Coax 1	S1	Dolby D + Dolby PLII Movie	Dolby D 5.1	DTS 5.1 Movie	Dolby PLII Movie	Dolby PLII Movie
LD	Coax 2	S2	Dolby D + Dolby PLII Movie	Dolby D 5.1	DTS 5.1 Movie	Dolby PLII Movie	Dolby PLII Movie
SAT	Opt 1	S3	Dolby D + Dolby PLII Movie	Dolby D 5.1	DTS 5.1 Movie	Dolby PLII Movie	Dolby PLII Movie
VCR	Disabled	VCR	N/A	N/A	N/A	N/A	Dolby PLII Movie
TV	Disabled	S4	N/A	N/A	N/A	N/A	Dolby PLII Movie
CD	Disabled	B1	N/A	N/A	N/A	N/A	Preamp
Tuner	Disabled	S5	N/A	N/A	N/A	N/A	Preamp
Aux 1	Disabled	7.1 Input	N/A	N/A	N/A	N/A	N/A
Aux 2 (Game)	Opt 2	S6	N/A	Dolby D 5.1	DTS 5.1	Dolby PLII Movie	Preamp
Tape	Disabled	Tape	N/A	N/A	N/A	N/A	Preamp

Note

Audio factory defaults for the Showcase Processor do not need to be configured if your system matches the factory defaults.

Table 5, on the next page, shows the audio operating modes available with the Showcase Processor. See also **Appendix: Operating Modes for the Showcase Processor**, on page 70, for descriptions of operating modes listed in Table 5.

Table 5 Showcase Processor Audio Operating Modes

Possible Default Operating Modes	Digital Signals (4 formats)				Analog Signal	
	Dolby Digital 2.0	Dolby Digital 5.1	DTS 5.1	PCM		
Dolby D + PLII Movie	YES	—	—	—	—	—
Dolby D + PLII Movie + THX	YES	—	—	—	—	—
Dolby D + PLII Music	YES	—	—	—	—	—
Dolby D + PLII Matrix	YES	—	—	—	—	—
Dolby D + Dolby Pro Logic	YES	—	—	—	—	—
Dolby D + Pro Logic + THX	YES	—	—	—	—	—
Dolby D 2.0	YES	—	—	—	—	—
Dolby D 5.1	—	YES	—	—	—	—
Dolby Digital EX ¹	—	YES	—	—	—	—
Dolby D 5.1 + THX	—	YES	—	—	—	—
Dolby D 5.1 + THX Surr EX ¹	—	YES	—	—	—	—
Dolby PLII Movie	—	—	—	YES	YES	YES
Dolby PLII Movie + THX	—	—	—	YES	YES	YES
Dolby PLII Music	—	—	—	YES	YES	YES
Dolby PLII Matrix	—	—	—	YES	YES	YES
Dolby Pro Logic	—	—	—	YES	YES	YES
Dolby Pro Logic + THX	—	—	—	YES	YES	YES
DTS 5.1 Movie ³	—	—	YES	—	—	—
DTS 5.1 Movie + THX ³	—	—	YES	—	—	—
DTS 5.1 Music ³	—	—	YES	—	—	—
DTS 5.1 Only ^{2,3}	—	—	YES	—	—	—
DTS Neo:6 Cinema	—	—	—	YES	YES	YES
DTS Neo:6 Cinema + THX	—	—	—	YES	YES	YES
DTS Neo:6 Music	—	—	—	YES	YES	YES
Krell Music Surround	—	—	—	YES	YES	YES
Preamp	—	—	—	—	—	YES
Stereo	—	—	—	YES	YES	YES

¹ The DOLBY DIGITAL EX and DOLBY D 5.1 + THX SURR EX operating modes are available only when your system has 6 or 7 channels.

² DTS 5.1 ONLY sets an input to receive only DTS 5.1 information. When this mode is selected, you are unable to select a default mode for PCM, Dolby Digital 2.0, and Dolby Digital 5.1 signals; the input will playback only DTS 5.1 material.

³ When the Showcase Processor detects a DTS 5.1 signal and engages the default mode selected for a DTS 5.1 signal, DTS-ES MATRIX 6.1 and DTS-ES MATRIX 6.1 + THX are accessible by pressing the M2 button or key. The DTS-ES MATRIX 6.1 operating mode is available only when your system has 6 or 7 channels.

Note

The DOLBY DIGITAL EX, DOLBY D 5.1 + THX SURR EX, DTS-ES DISCRETE 6.1, and DTS-EX MATRIX 6.1 operating modes are available only when your system has 6 or 7 channels.

Assign Analog Audio Inputs

Select CONFIGURE AUDIO from the CONFIGURE DEVICES menu. The ASSIGN AUDIO INPUTS screen appears:

Assign Audio Inputs Screen

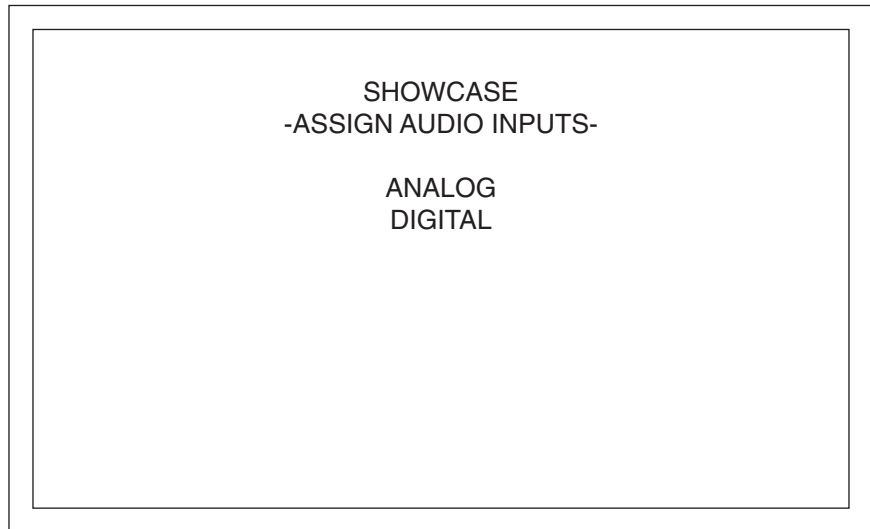

Select ANALOG. The ASSIGN ANALOG AUDIO INPUT screen appears.

Assign Analog Audio Input Screen

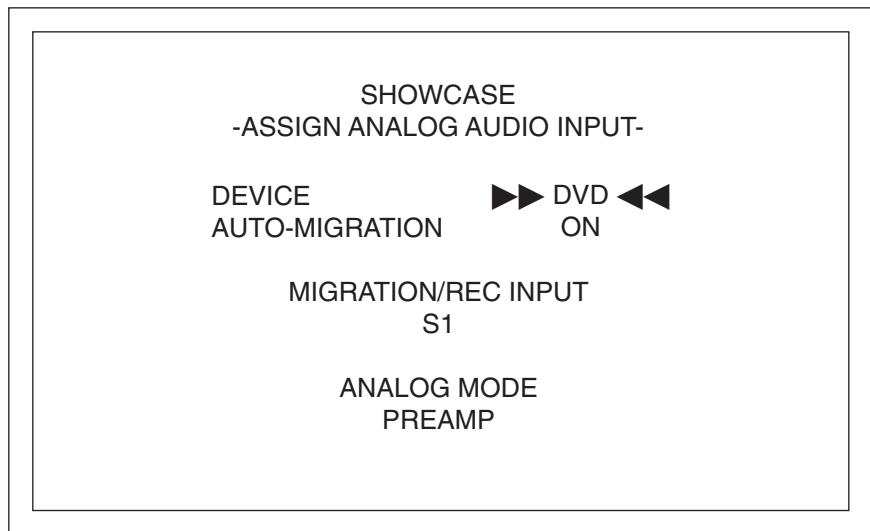

How To Navigate the Menu and Make a Selection

1. Use the direction keys to scroll from line to line.
2. Press enter to select a line.
3. Use the direction keys to scroll through options within a line.
4. Press enter to select and set an option.
5. Use the direction keys to scroll to the next line.

Use the direction and enter keys to scroll through and select the device you want to configure, select the MIGRATION/REC input, and choose the analog mode, if mode options are available.

System Configuration, continued

Assign Analog Audio Inputs, continued

AUTO-MIGRATION ON allows the Showcase Processor to switch to the analog input automatically, a feature that is particularly useful for SACD players.

The analog signal must be assigned, not DISABLED, in order for auto-migration to be active.

Assign Digital Audio Inputs

After the selections for analog audio inputs are entered, press the previous key. You return to the ASSIGN AUDIO INPUTS screen. Select DIGITAL. The ASSIGN DIGITAL AUDIO INPUT screen appears.

Assign Digital Audio Input Screen

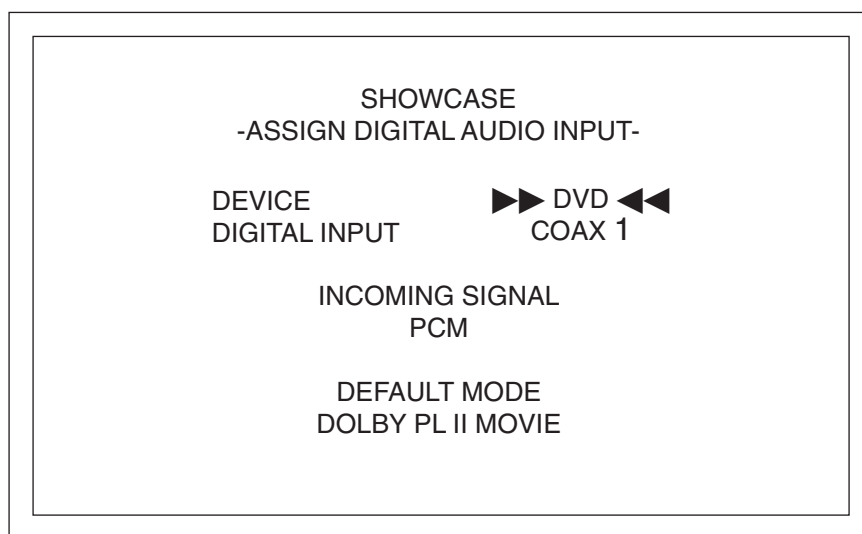

Use the direction and enter keys to scroll through and select the digital device you want to configure, select the digital input, and choose the default mode for the four major surround sound digital formats: Dolby Digital 2.0, Dolby Digital 5.1, DTS 5.1, and PCM. Each of these signals has options under DEFAULT MODE. If a THX Surround EX or DTS ES encoded disc is played, the Showcase Processor will automatically select one of these modes.

Notes

The digital input must be set to DISABLED to use the analog input, and it must be set to DISABLED to use preamp mode.

PREVIOUS holds the last selected digital input.

The DOLBY DIGITAL EX, DOLBY D 5.1 + THX SURR EX, DTS-ES DISCRETE 6.1, and DTS-EX MATRIX 6.1 operating modes are available only when your system has 6 or 7 channels.

When the device is configured, press the previous key (74) twice to return to the CONFIGURE DEVICES menu.

Configure Trigger

The final option on the CONFIGURE DEVICES menu is CONFIGURE TRIGGER. This option allows you to customize the operation of the four remote output 12 VDC (12 Volt trigger) connectors (54) on the back panel.

Select CONFIGURE TRIGGER from the CONFIGURE DEVICES menu. The CONFIGURE TRIGGER screen appears:

Configure Trigger Screen

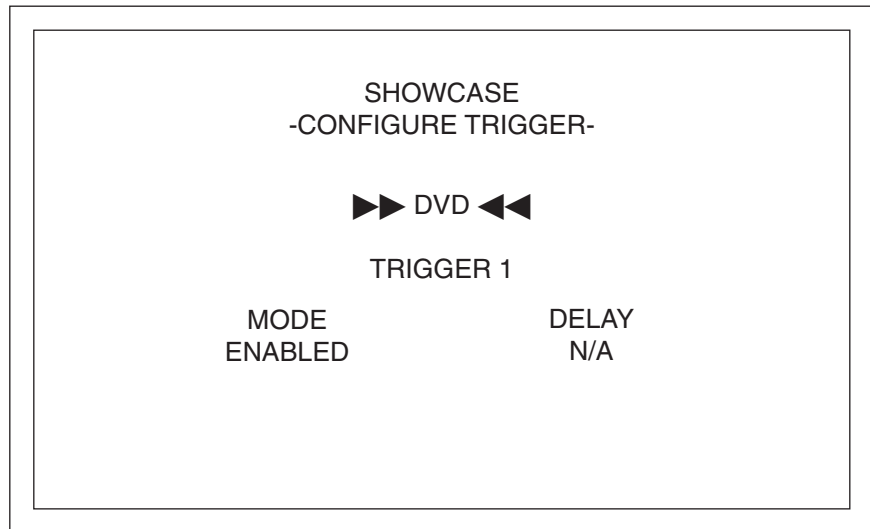

Use the direction and enter keys to select the source device, the trigger(s) you want to configure, and the mode and delay for each trigger you select. The delay is only available when a trigger is set to ENABLED. There is a three second delay after you select ENABLED, before the trigger turns on. The trigger turns off immediately when you select DISABLED.

How To Navigate the Menu and Make a Selection

1. Use the direction keys to scroll from line to line.
2. Press enter to select a line.
3. Use the direction keys to scroll through options within a line.
4. Press enter to select and set an option.
5. Use the direction keys to scroll to the next line.

Configuring Additional Inputs

For any of the other devices available [LD, SAT, VCR1, TV, CD, TUNER, AUX1, AUX2 (GAME), TAPE], use the same process outlined above. Krell recommends that you use the step-by-step menu to configure each device completely, then configure the next device.

When you have configured all the devices you want the Showcase Processor to recognize, press the previous button (74) twice to return to the main menu.

How To Navigate the Menu and Make a Selection

1. Use the direction keys to scroll from line to line.
2. Press enter to select a line.
3. Use the direction keys to scroll through options within a line.
4. Press enter to select and set an option.
5. Use the direction keys to scroll to the next line.

**STEP 5
CONFIGURE LEVEL
ADJUSTMENT**

Use the fifth option on the main menu, CONFIGURE LEVEL ADJUSTMENT to set trims, adjust modes, and set the main volume limit.

Trims add a fixed positive or negative volume offset that allows you to compensate for devices with different volume levels. After adjusting the volume trim, you can easily switch between these inputs without changes in volume levels.

Note

The master volume control has a numerical range from 0 to 152, with 31 as the Dolby reference level. The center loudspeaker, surround loudspeakers, and subwoofer volume trims have a range of +/- 15 dB.

Select CONFIGURE LEVEL ADJUSTMENT from the main menu. The CONFIGURE LEVELS screen appears:

Configure Levels Screen

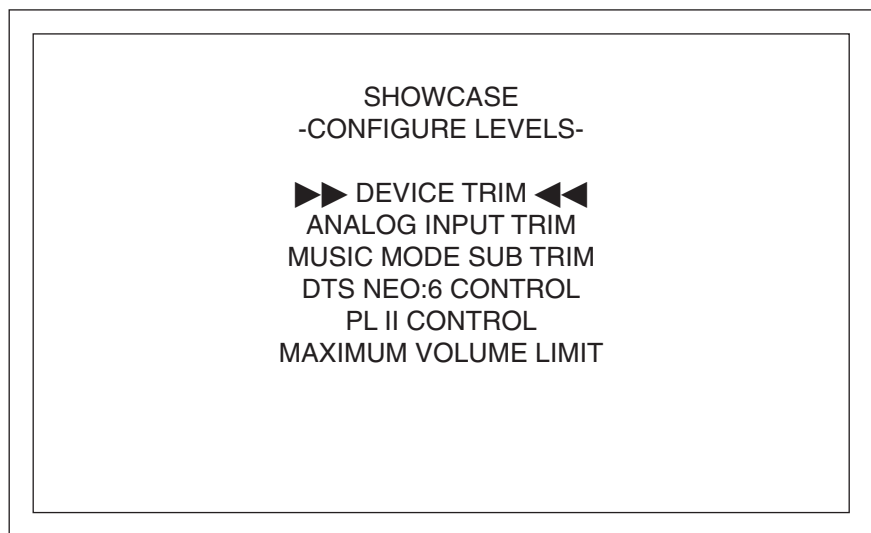

Device Trim

The `DEVICE TRIM` is a master volume trim that is activated when an input device is selected; it has a range of ± 15 dB.

Select `DEVICE TRIM` from the `CONFIGURE LEVELS` menu. The `DEVICE TRIM` screen appears:

Device Trim Screen

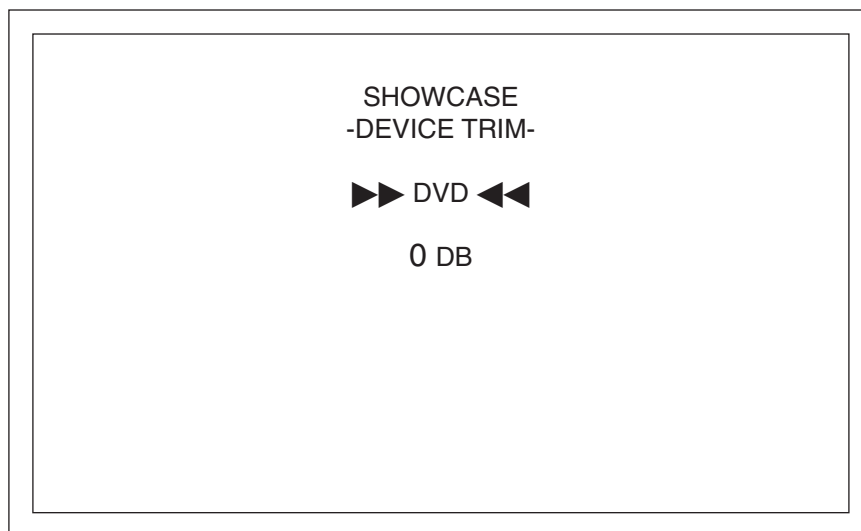

Use the direction and enter keys to select the devices for which you want to set trims, and the trim level for each. When you have made your selections, press the previous key once to return to the `CONFIGURE LEVELS` screen.

How To Navigate the Menu and Make a Selection

1. Use the direction keys to scroll from line to line.
2. Press enter to select a line.
3. Use the direction keys to scroll through options within a line.
4. Press enter to select and set an option.
5. Use the direction keys to scroll to the next line.

**Please read before
configuring
analog input trim**

An analog device must be selected before the analog input trim option functions. The following screen appears if an analog device is not selected:

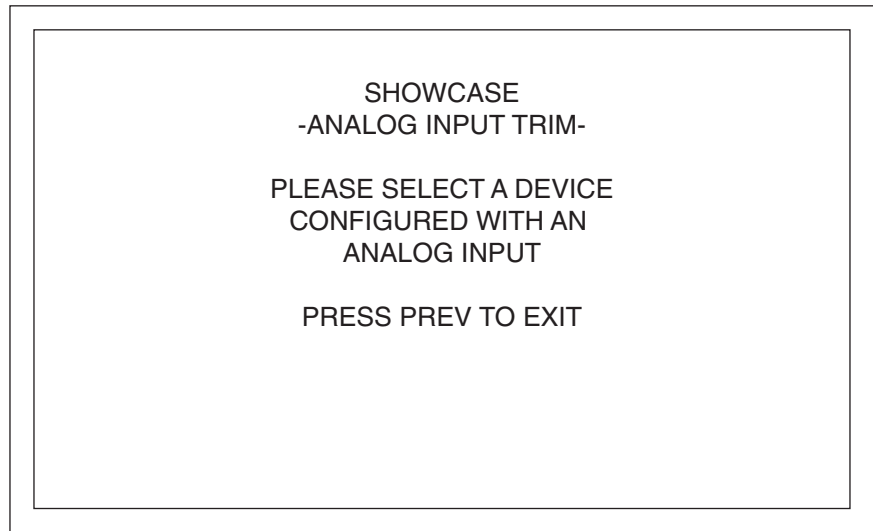

Analog Input Trim

Use the ANALOG INPUT TRIM menu to measure the level of an analog input source to the Showcase Processor.

Select ANALOG INPUT TRIM from the CONFIGURE LEVELS menu. The ANALOG INPUT TRIM screen appears:

Analog Input Trim Screen

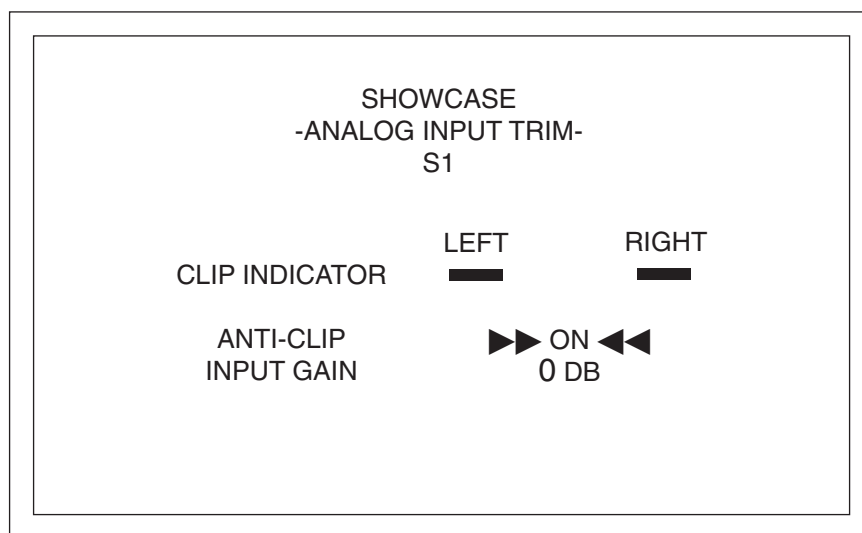

Use the direction keys (75) to select the anti-clip option you want (ON or OFF) and the input gain decibel level. Krell recommends leaving anti-clip ON.

ANTI-CLIP

ON

The anti-clip function measures the signal level and prevents the input signal from overloading (clipping) the analog-to-digital converters.

OFF

Disengages the anti-clip function. This may result in distorted sound.

INPUT GAIN

Boost weaker signals by increasing the input gain value. Use the direction and enter keys to select the number of dB.

To maximize your system's signal-to-noise ratio without clipping, increase the input gain value applied to the signal until you see the clip indicator illuminate on the screen; then back the input gain value off one step. The optimal signal gain value will vary from source to source.

After selecting the anti-clip and input gain options for your analog devices, press the previous key (74) once to return to the CONFIGURE LEVELS menu.

How To Navigate the Menu and Make a Selection

1. Use the direction keys to scroll from line to line.
2. Press enter to select a line.
3. Use the direction keys to scroll through options within a line.
4. Press enter to select and set an option.
5. Use the direction keys to scroll to the next line.

Music Mode Sub Trim

Use the MUSIC MODE SUB TRIM menu to adjust the trim for the subwoofer, during music mode playback. The adjustment range is -10 to +10 dB. Music mode sub trim is active when using the PARTY, GENERAL ADMISSION, FRONT ROW, ON STAGE, ENHANCED STEREO, ORCHESTRA, MEZZANINE, FULL RANGE + SUB, and DTS NEO:6 modes.

Select MUSIC MODE SUB TRIM from the CONFIGURE LEVELS menu. The MUSIC MODE SUB TRIM screen appears:

Music Mode Sub Trim Screen

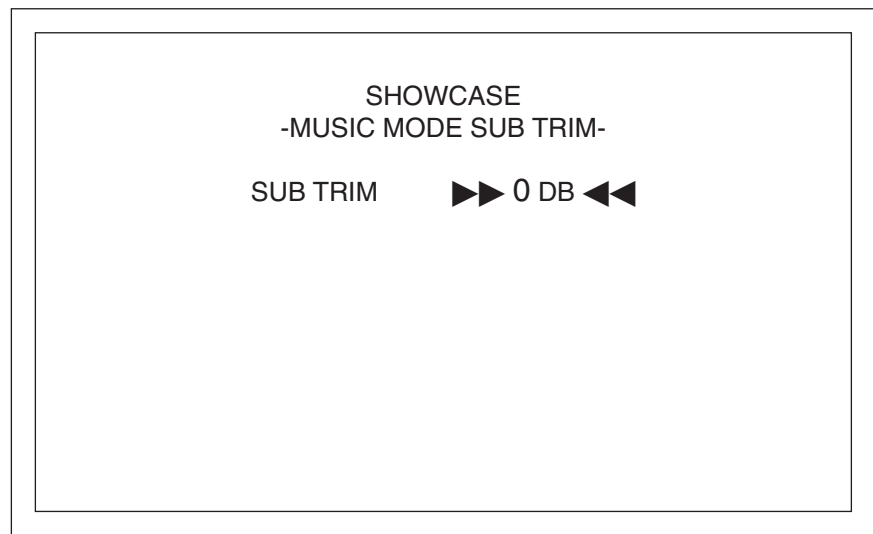

After setting the selection, press the previous key once to return to the CONFIGURE LEVELS menu screen.

DTS Control

Use the DTS CONTROL menu to adjust the signal for DTS Neo:6 music mode, which derives a 6.0 signal from two-channel material. The center gain adjusts the amount of center channel information present in the left and right loudspeakers. The adjustment range is 0 (no center channel information subtracted (wide sound field) to 5 (maximum level of center channel information subtracted from the left and right channels (focused sound field).

Select DTS NEO:6 CONTROL from the configure levels menu. The DTS CONTROL screen appears:

DTS Control Screen

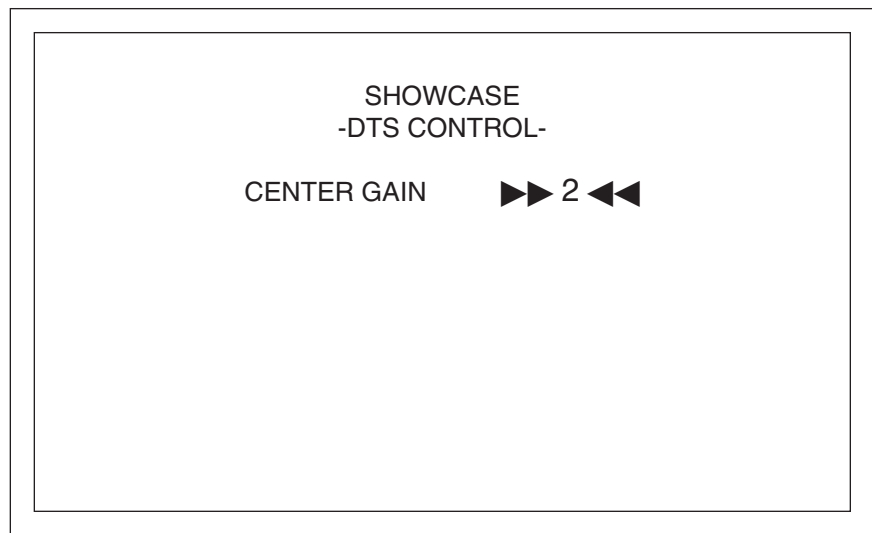

After setting the selection, press the previous key once to return to the CONFIGURE LEVELS screen.

How To Navigate the Menu and Make a Selection

1. Use the direction keys to scroll from line to line.
2. Press enter to select a line.
3. Use the direction keys to scroll through options within a line.
4. Press enter to select and set an option.
5. Use the direction keys to scroll to the next line.

System Configuration,
continued

PLII Control

Use the PLII CONTROL menu to adjust the signal for Dolby Pro Logic II music mode, which derives a 5.0 signal from two-channel material.

DIMENSION

You can adjust the sound field toward the front or rear loudspeakers, to achieve a more suitable balance from all loudspeakers with certain recordings. The adjustment range is 0 (maximum surround) to 6 (center). The default setting is 3 (neutral).

CENTER WIDTH

You can adjust how much of the center output signal is spread to the left and right channel outputs. The adjustment range is from 0 (maximum center channel signal) to 7 (lowest signal; effectively mutes the center channel).

Select PLII CONTROL from the CONFIGURE LEVELS menu. The PLII CONTROL screen appears:

PLII Control Screen

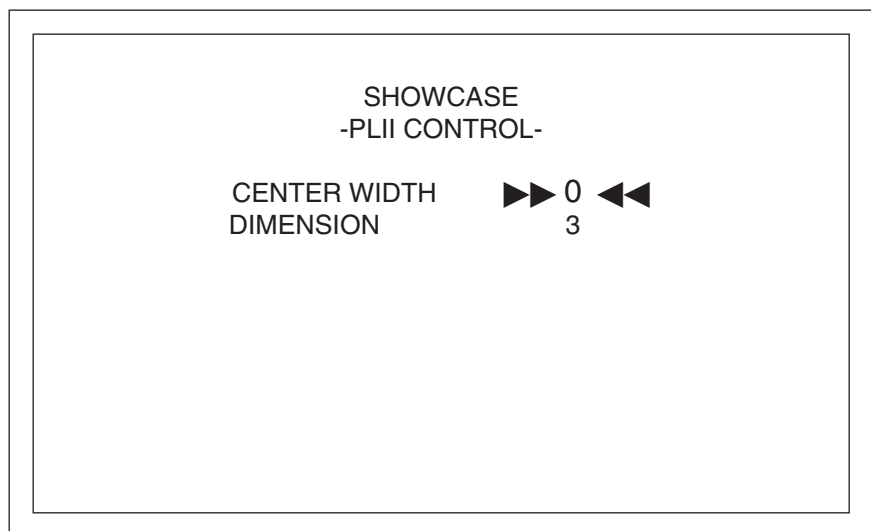

After setting your selections, press the previous key once to return to the CONFIGURE LEVELS screen.

System Configuration,
continued

Maximum Volume Limit

Use the MAXIMUM VOLUME LIMIT menu to set the maximum volume for your system, from 0-152.

Select MAXIMUM VOLUME LIMIT from the CONFIGURE LEVELS menu. The MAXIMUM VOLUME LIMIT screen appears:

**Maximum Volume Limit
Screen**

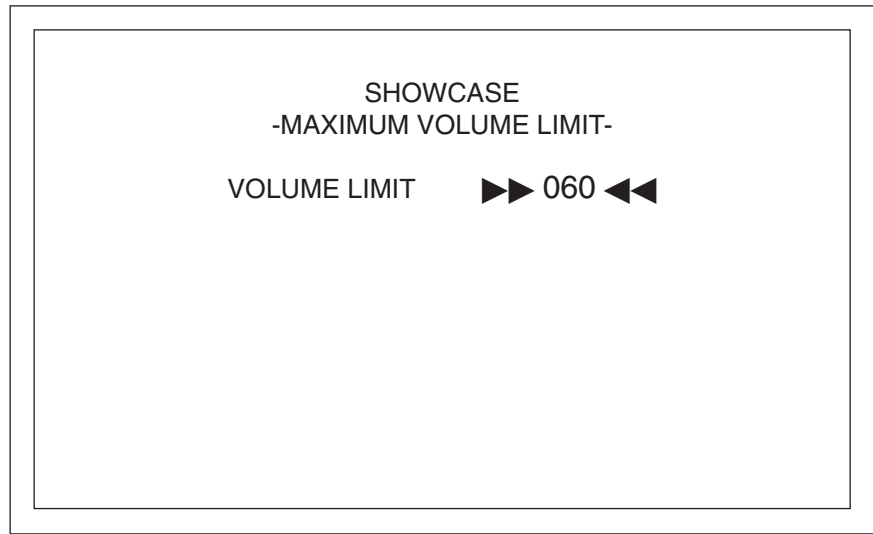

After setting your selection, press the previous key once to return to the CONFIGURE LEVELS screen. When you have finished configuring LEVELS, press the previous key (54) twice to return to the MAIN MENU screen.

**How To Navigate the Menu
and Make a Selection**

1. Use the direction keys to scroll from line to line.
2. Press enter to select a line.
3. Use the direction keys to scroll through options within a line.
4. Press enter to select and set an option.
5. Use the direction keys to scroll to the next line.

**STEP 6
OPERATION**

The final option on the main menu screen, OPERATION, lets you select screen background color, position and display time for on-screen display (OSD), set audio operation, program a learning remote control, and adjust frequency response using the Krell Digital Room Equalizer.

Select OPERATION from the MAIN MENU. The OPERATION MENU screen appears, with the cursor blinking at OSD OPERATION:

Operation Screen

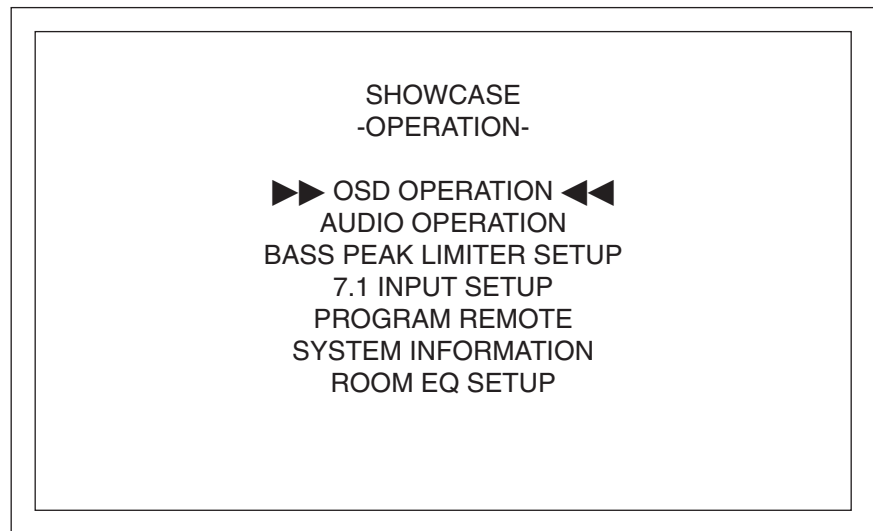

OSD Operation

Press enter to access the OSD OPERATION screen:

OSD Operation Screen

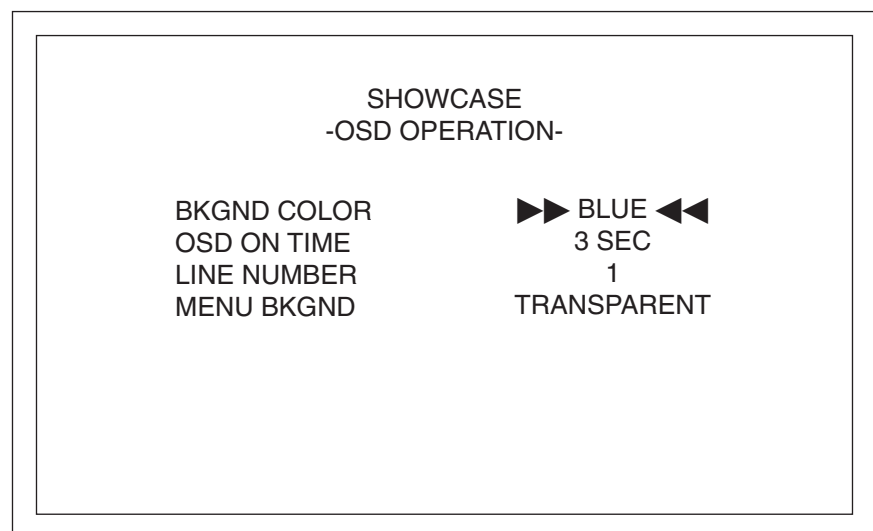

System Configuration, continued

OSD Operation, continued

The on-screen display feature allows you to customize on-screen display options.

BKGND COLOR

Choose the background color of the video display screen. This color choice is only applicable to composite and S-video inputs. The background color is always black for component signals.

OSD ON TIME

Choose the number of seconds (0-10) that the on-screen display information remains on the screen.

LINE NUMBER

Choose the location (from 1, top line, to 10, bottom line) at which the on-screen display appears.

MENU BKGND

Choose the menu background, either **SOLID** or **TRANSPARENT**. The **SOLID** setting blanks out an active video signal and only displays menu information. The **TRANSPARENT** setting overlays the menu screens on top of an active video signal, allowing configuration changes while continuing to watch a video signal.

After setting your selections, press the previous key (74) once to return to the **OPERATION** menu.

How To Navigate the Menu and Make a Selection

- 1. Use the direction keys to scroll from line to line.**
- 2. Press enter to select a line.**
- 3. Use the direction keys to scroll through options within a line.**
- 4. Press enter to select and set an option.**
- 5. Use the direction keys to scroll to the next line.**

Audio Operation

The next item in the OPERATION menu, AUDIO OPERATION, allows you to customize audio operation such as mute, mode holds, auto-switching, and dynamic range.

Select AUDIO OPERATION from the OPERATION menu. The AUDIO OPERATION screen appears:

Audio Operation Screen

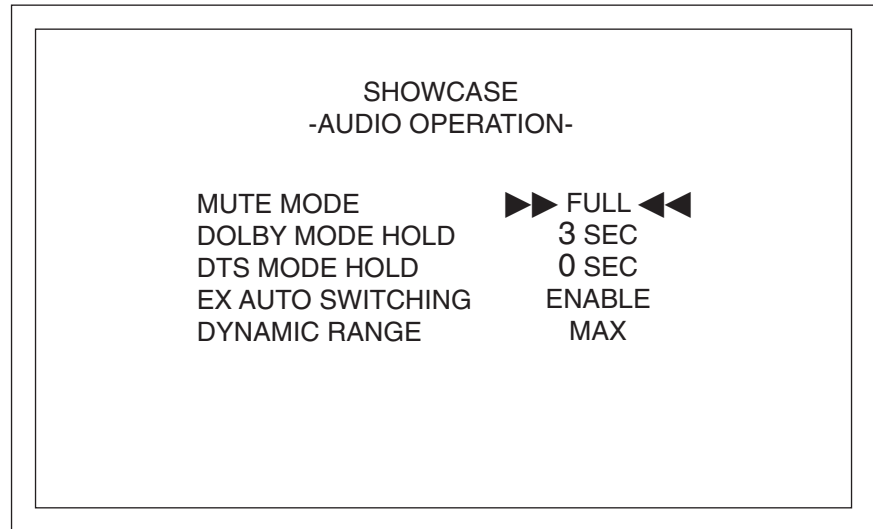

Use the direction and enter keys to scroll through and select options for audio operation:

MUTE MODE

The mute mode lets you select FULL mode in which the output is completely silenced or -20 dB in which the output is reduced by 20 dB and may still be audible.

DOLBY MODE HOLD

Dolby mode hold sets the time your Showcase Processor remains in Dolby Digital mode when the incoming bitstream is interrupted. Bitstreams are interrupted in some devices when you press and release fast forward, track back/forward, or change channels for a compact disc, video disc, or satellite receiver. The adjustment range is 0 (no hold) to 30 seconds.

DTS MODE HOLD

DTS mode hold sets the time your Showcase Processor remains in DTS mode when the incoming bitstream is interrupted. Bitstreams are interrupted in some devices when you press and release fast forward, track back/forward, or change channels for a compact disc, video disc, or satellite receiver. The adjustment range is 0 (no hold) to 30 seconds.

System Configuration, continued

Audio Operation, continued

EX AUTO SWITCHING

When **ENABLED**, the Showcase Processor will automatically engage THX Surround EX decoding if it receives a bitstream that is encoded in this format. When this feature is **DISABLED**, you must manually select THX Surround EX decoding.

DYNAMIC RANGE

Use the dynamic range screen to adjust the dynamic range of the Showcase Processor. Options are:

NORMAL

11 dB of compression

MAX

no compression

NIGHT

22 dB of compression

After setting your selections, press the previous key (74) once to return to the **OPERATION** menu.

How To Navigate the Menu and Make a Selection

1. Use the direction keys to scroll from line to line.
2. Press enter to select a line.
3. Use the direction keys to scroll through options within a line.
4. Press enter to select and set an option.
5. Use the direction keys to scroll to the next line.

Bass Peak Limiter Setup

The BASS PEAK LIMITER SETUP menu lets you turn the bass peak limiter option ON or OFF. When this option is ON, you can then set the maximum amount of .1 (or LFE) and redirected bass that is sent to your subwoofer. If you do not have a subwoofer, this option limits the maximum amount of 1 (or LFE) and redirected bass that is sent to your full range front and/or surround loudspeakers.

Select BASS PEAK LIMITER SETUP from the OPERATION menu. The BASS PEAK LIMITER SETUP screen appears,, with the cursor blinking at OFF:

Bass Peak Limiter Setup Screen

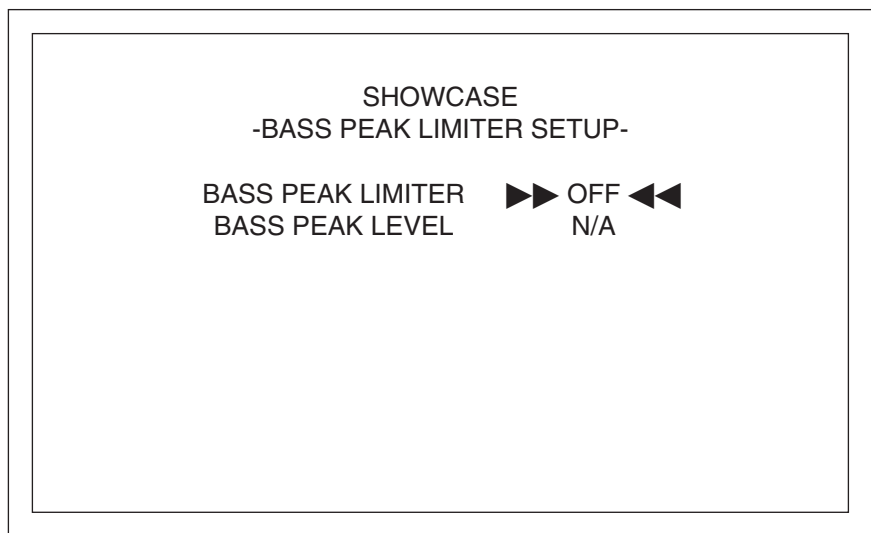

When you select ON, the BASS PEAK LEVEL reverts to 0. Use the up direction key to increase the output of the noise generator. Select the volume level limit (0-90) by increasing the noise generator until the bass sounds distorted. Then set your selection at that level, or slightly below.

After setting your selections, press the previous key (74) once to return to the OPERATION screen.

7.1 Input Setup

The 7.1 INPUT SETUP menu allows you to select the 7.1 inputs that are connected.

Select 7.1 INPUT SETUP from the OPERATION menu. The 7.1 INPUT SETUP screen appears:

7.1 Input Setup Screen

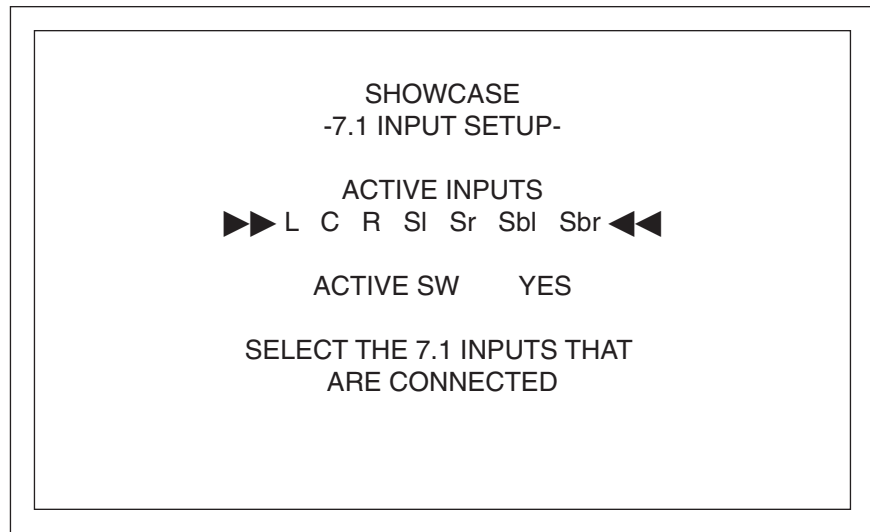

ACTIVE INPUTS

Use the direction keys to find the input combination that matches your connections. Press enter to set the selection.

ACTIVE SW

Select YES if subwoofer is present and NO if it is not.

After setting your selections, press the previous key (74) once to return to the OPERATION menu.

How To Navigate the Menu and Make a Selection

1. Use the direction keys to scroll from line to line.
2. Press enter to select a line.
3. Use the direction keys to scroll through options within a line.
4. Press enter to select and set an option.
5. Use the direction keys to scroll to the next line.

Program Remote

The PROGRAM REMOTE menu allows you to program a learning remote control to operate the Showcase Processor.

Note

The infrared sensor on the front panel is inactive until programming is complete.

Select PROGRAM REMOTE from the OPERATION menu. The PROGRAM REMOTE screens appear:

Program Remote Screens

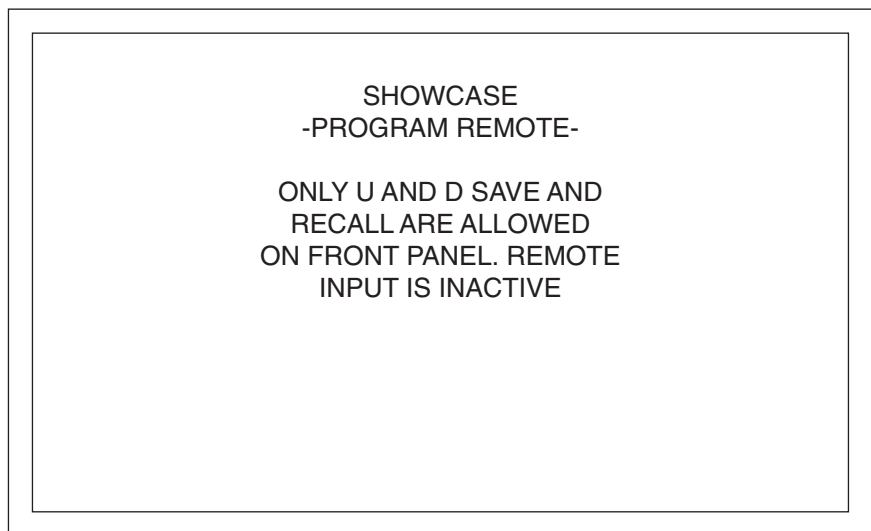
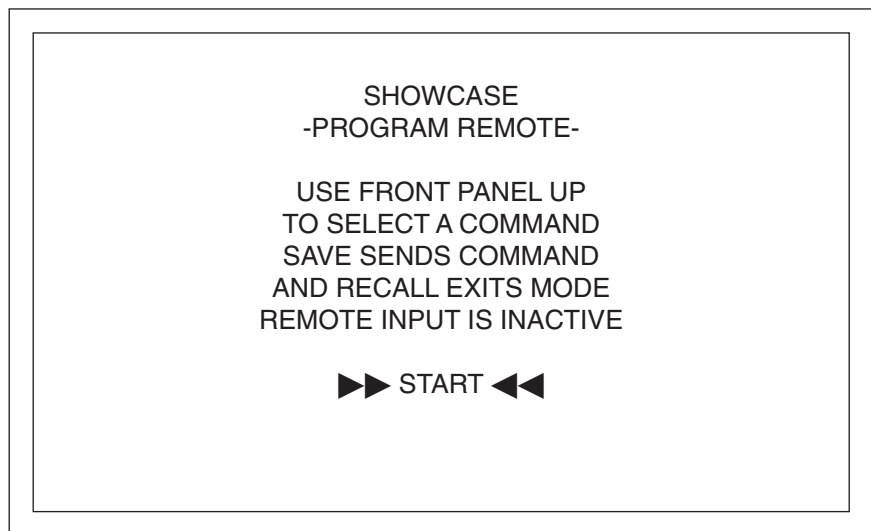

System Configuration, continued

Program Remote, continued

1. Press the front panel level buttons (28) to select a command. The command appears on the front panel display window (22).
2. Place the programmable remote in program mode (see the learning remote user manual).
3. Place the infrared sensor of the programmable remote so that it faces the infrared emitter (15) on the Showcase Processor front panel.
4. Press and hold the save button (27) on the Showcase Processor front panel until the programmable remote has learned the code (see the learning remote user manual for information on the time needed to learn the code).
5. Select and save as many commands as desired.
6. Press the recall button (29) on the front panel to exit the program mode.

Note

Press the previous button (74) to return to the OPERATION menu.

System Information

The SYSTEM INFORMATION menu displays AC line frequency, the version of software that your component is currently using, and information about the EEPROM.

Select SYSTEM INFORMATION from the OPERATION menu. The SYSTEM INFORMATION screens appear:

System Information Screen

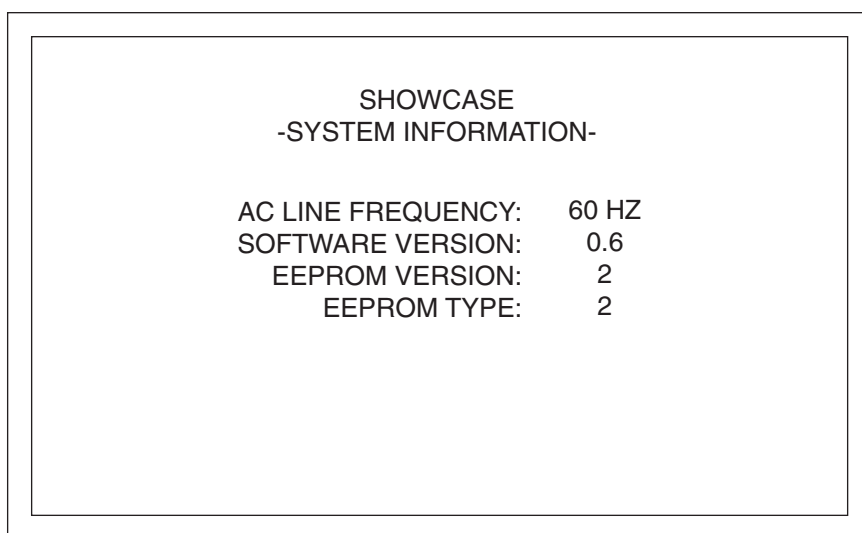

How To Navigate the Menu and Make a Selection

1. Use the direction keys to scroll from line to line.
2. Press enter to select a line.
3. Use the direction keys to scroll through options within a line.
4. Press enter to select and set an option.
5. Use the direction keys to scroll to the next line.

**Please read
before configuring
Room EQ Setup**

The Room EQ Setup accesses the Digital Room Equalizer, a feature designed by Krell to provide every adjustment from simple bass and treble to comprehensive room correction. The Digital Room Equalizer enables you to adjust frequency response through three discrete bands (I, II, and III). The four adjustable parameters available are filter type, frequency, shape, and level.

There are four Room EQ setup memories, each of which saves every parameter set for every filter, for every channel. Each setup memory can save a configuration, for example, one for stereo music, one for multichannel music, one for movie surround, and one for video game software.

You can adjust the filters for Showcase Processor channels globally or individually. Up to three filters can be configured to act equally on all seven channels of audio. Alternatively, each filter can be configured separately for each individual channel.

ADJUSTABLE PARAMETERS

TYPE

Six filter types are available for each filter: Notch Filter, Peaking Filter, High Shelf Filter, Low Shelf Filter, High Pass Filter (HPF) and Low Pass Filter (LPF). Each of the filter types available has a unique effect on frequency response.

The following three parameters for filters may be configured, depending on the filter type selected:

FREQ

The center/cutoff frequency can be specified for all six filter types, from 20 Hz to 16 kHz in 1/3 octave increments.

SHAPE

Shape controls the bandwidth of the filter and is adjustable on the Notch and Peaking filter types, from 0.4 to 9 octaves. Shape is fixed at a 6 dB / octave slope for the High and Low Pass Filters. This parameter is not available for the High and Low Shelf Filters.

LEVEL

Level is adjustable on the Peaking, High Shelf and Low Shelf filters, from -12 dB to +6 dB. Level is fixed for the Notch Filter at -90 dB. This parameter is not available for the High and Low Pass Filters.

System Configuration, continued

CHANNEL SELECTION

When the channel field is set to ALL, the ROOM EQ SETUP menu displays the filter settings which apply to all channels and all of the channels are filtered in the same manner. When the channel parameter selection is set to only one of the channels (L, C, R, LS, RS, LB, RB, S), the filter settings apply to each of the channels individually.

IMPORTANT

The selection ALL overrides individually configured channels.

APPLYING YOUR CONFIGURATIONS

Your configurations take effect only when you press enter in the APPLY field. APPLY allows you to hear the effect of the selections you have made without leaving the menu, if you have a source device playing.

SAVING ROOM EQ SETUP MEMORY

There are four selectable memories associated with the ROOM EQ SETUP menu. Values are saved automatically when you enter a selection.

Room EQ settings are stored in the Showcase Processor memory in the same manner as all of the other software settings, for example the selections for loudspeaker setup and device configuration. See ***Saving and Recalling Customized Settings and Restoring the Factory Default System Settings, on page 67, for more information.***

ACCESSING ROOM EQ SETUP MEMORY

When the Showcase Processor is in the operational mode, access the saved EQ configurations by pressing the right (arrow) key on the remote. Use the up and down (arrow) remote keys to scan through the four memories and OFF.

Note

Exit the main configuration menu by pressing the menu key (82) on the remote. The Showcase Processor is now in operational mode. Press the right arrow directional key followed by the up and down directional keys (75) to scroll through the four EQ memories and OFF.

How To Navigate the Menu and Make a Selection

1. Use the direction keys to scroll from line to line.
2. Press enter to select a line.
3. Use the direction keys to scroll through options within a line.
4. Press enter to select and set an option.
5. Use the direction keys to scroll to the next line.

Room EQ Setup

The final item on the OPERATION menu, ROOM EQ SETUP, allows you to adjust your loudspeaker to your listening area using the Krell Digital Room Equalizer. Select ROOM EQ SETUP from the OPERATION menu. The ROOM EQ SETUP screen appears, with the cursor blinking at OFF:

Room EQ Setup Screen

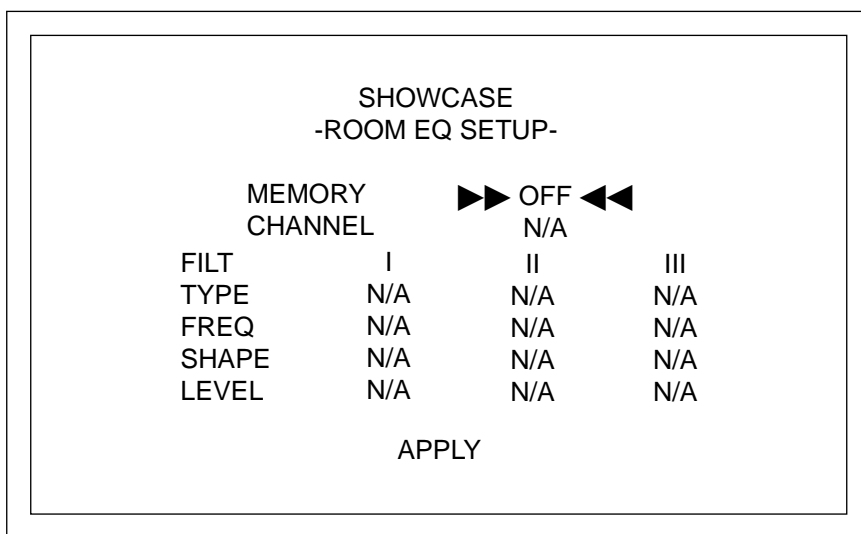

Use the direction and enter keys on the Showcase Processor remote control to scroll through and select the following step-by-step options for audio operation:

MEMORY

Navigate to one of the four memory locations and enter your selection. When the Memory field is set to OFF (the factory default), all of the filters are disabled.

CHANNEL

Navigate to CHANNEL and select ALL to apply your configurations to all channels at once or select any individual channel to apply your configurations to that channel. Enter your selection.

IMPORTANT

The selection ALL overrides individually configured channels.

System Configuration, continued

Room EQ Setup continued

TYPE

Navigate to TYPE, and configure one, two, or all of the three bands (I, II, III) for FREQ, SHAPE, and LEVEL.

Note

It is not necessary to configure all three filters, you may configure only one or two filters.

Not all parameters are adjustable for all filter types.

APPLY

Select APPLY and set the selection, if you want to hear your configuration. The Room EQ Setup configurations you have just selected audible if you have a source device playing.

After selecting the appropriate loudspeaker configuration for your system, press the previous key (74) twice to return to the main configuration menu.

Exit the main configuration menu by pressing the menu key (82) on the remote. The Showcase Processor is now in the operational mode.

How To Navigate the Menu and Make a Selection

1. Use the direction keys to scroll from line to line.
2. Press enter to select a line.
3. Use the direction keys to scroll through options within a line.
4. Press enter to select and set an option.
5. Use the direction keys to scroll to the next line.

Saving and Recalling Customized Settings and Restoring the Factory Default System Settings

SAVING CUSTOMIZED SETTINGS

To save the customized settings that you have entered, press and hold the save button (27) for approximately four seconds. The front panel displays **SAVING SETUP** while the settings are being stored in the nonvolatile memory of the Showcase Processor.

RECALLING CUSTOMIZED SETTINGS

To retrieve your system's saved settings, press and hold the recall button (29) for approximately four seconds. The front panel displays **RECALL SETUP** while the settings are being retrieved from the non-volatile memory of the Showcase Processor. Any settings that have been saved will be available through recalling system setup.

RESTORING THE FACTORY DEFAULT SYSTEM SETTINGS

To replace all system settings with the factory default settings, follow these steps:

1. Press the front panel power button (1) to put your system into the operational mode.
2. Simultaneously press the recall button (29) and the power button (1). The front panel displays:

PLEASE WAIT

INITIALIZING

Your customized settings for the Showcase Processor revert to the factory default settings.

Note

*If you save your settings, they are still in memory after you restore the factory default system settings. Follow **Recalling Customized Settings** above to retrieve your customized settings.*

Operating the Showcase Processor

ON/OFF/STAND-BY

After the Showcase Processor is connected to source devices and amplifiers, and the system setup configured, the Showcase Processor is ready for operation.

1. Insert the AC power cord into the IEC connector (52) on the Showcase Processor. Insert the other end into the AC wall receptacle.
2. Move the back panel power switch (51) into the up (on) position.
3. The red stand-by LED on the front panel illuminates. The words PLEASE WAIT, INITIALIZING appear in the front panel display (22). When the initializing message disappears, the Showcase Processor is ready to be powered on.

The front panel display shows volume, input information, and selected mode. After five seconds of inactivity, the display becomes blank.

4. Use either the front panel power button (1) or the remote control power pre key (54) to power on the Showcase Processor. The blue power LED (2) on the front panel illuminates. The Showcase Processor is now in the operational mode.
5. To return to stand-by, press the front panel power button or power pre key again.

Note

Krell recommends that the back panel power switch remain up (on) at all times.

TAPE INPUT AND OUTPUT

The Showcase Processor has a discrete tape input and output. The tape output is used to send an input signal from any analog input (S-1 through S-7, B-1, or VCR) to a recording device or processor. You can use the tape feature in three ways:

1. Use the tape input to playback pre-recorded tapes.
2. Use the tape input to compare the output signal of a three-head analog tape recorder to the output signal of an audio source. Press the tape button (15) or key (64) to switch between the tape recorder output (LED illuminated) and the input source (LED not illuminated).

Operating the Showcase Processor, *continued*

Tape Input and Output, *continued*

3. Use the tape output to create a processor loop, when the Showcase Processor is connected to a graphic equalizer or other ancillary equipment. Connect the equipment to the Showcase Processor tape outputs (34) as described in the equipment manufacturer's manual. Press the tape button (15) or key (64) to switch between the processor output (LED illuminated) and the input source (LED not illuminated).

Notes

The tape output functions only with analog sources.

There is no tape output from the 7.1 multichannel input.

When changing sources, lower the volume to off or mute the output. This ensures that the next source played does not damage your system with a high output transient.

SIMULCAST

When you are listening to or viewing different devices that have different trigger settings (configured through the setup menus), you can retain a trigger setting using the previous (74) key.

For example, you have configured your Showcase Processor to turn on your TV monitor when trigger 4 is on and your CD player is set for TRIGGER 4 OFF. You want to watch TV and listen to a CD at the same time. If you press the TV button or key followed by the CD button or key, the TV monitor will turn off.

To keep the monitor on and turn on the CD player, follow these steps:

1. Press the TV button (10) or key (58) to select the device. Begin playing the device.
2. Press the prev key (74).
3. Press the CD button (11) or key (59). Begin playing the device.

Appendix: Operating Modes for the Showcase Processor

AUTOMATICALLY DETECTED MODES

The Showcase Processor automatically detects the following signals and automatically engages the appropriate operating mode for the following signals. Available default modes are listed in **Table 5**, see page 42:

DOLBY DIGITAL 2.0 OR DOLBY DIGITAL 2.0 + DOLBY PRO LOGIC

Select a Dolby Digital 2.0 or Dolby Digital 2.0 + Dolby Pro Logic default mode using the configuration menu. All modes listed under Dolby Digital 2.0, including the default mode you have selected, can be accessed using the M2 button or key.

DOLBY DIGITAL 5.1

Select a Dolby Digital 5.1 default mode using the configuration menu. All modes listed under Dolby Digital 5.1, including the default mode you have selected, can be accessed using the M2 button or key.

DOLBY DIGITAL EX

Dolby Digital EX creates six full-bandwidth output channels from 5.1-channel sources. This is done using a matrix decoder that derives three surround channels from the two in the original recording. For best results, Dolby Digital EX should be used with movie soundtracks recorded with Dolby Digital Surround EX. All modes listed under Dolby Digital EX, including the default mode you have selected, can be accessed using the M2 button or key.

DTS 5.1

Select a DTS 5.1 default mode using the configuration menu. All modes listed under DTS 5.1, including the default mode you have selected, can be accessed using the M2 button or key.

DTS-ES DISCRETE 6.1

The Showcase Processor engages DTS-ES Discrete 6.1 decoding. All of the following modes, plus DTS-ES DISCRETE 6.1 can be accessed using the M2 button or key: DTS-ES DISCRETE 6.1 + THX, DTS-ES MATRIX 6.1, DTS-ES MATRIX 6.1 + THX, DTS 5.1 MOVIE, DTS 5.1 MOVIE + THX, and DTS 5.1 MUSIC.

DTS-ES MATRIX 6.1

The Showcase Processor engages DTS ES Matrix 6.1 decoding. All of the following modes plus DTS-ES MATRIX 6.1 can be accessed using the M2 button or key: DTS-ES MATRIX 6.1 + THX, DTS 5.1 MOVIE, DTS 5.1 MOVIE + THX, and DTS 5.1 MUSIC.

Automatically Detected Modes, continued

THX SURROUND EX

The Showcase Processor engages THX Surround EX decoding. The following modes, plus THX SURROUND EX in M1, can be accessed using the M2 button or key or the THX button or key: DOLBY D 5.1 and DOLBY D 5.1 + THX.

Note

The DOLBY DIGITAL EX, DOLBY D 5.1 + THX SURR EX, DTS-ES DISCRETE 6.1, and DTS-EX MATRIX 6.1 operating modes are available only when your system has 6 or 7 channels.

USER SELECTABLE MODES

User selectable modes available on the Showcase Processor are listed below:

Dolby Pro Logic II Modes

DOLBY PRO LOGIC II

Dolby Pro Logic II is the next generation in Dolby Surround decoding. The Pro Logic II decoder takes 2 channels in and 5 channels out. It is designed specifically to decode all existing Dolby Surround programs with improved spatiality and directionality. Pro Logic II is also designed for use with unencoded stereo music recordings. This feature draws the listener into a three-dimensional space rather than hearing a flat, two-dimensional presentation.

There are 4 modes in which the Pro Logic II decoder can operate: movie mode (DOLBY PLII MOVIE), music mode (DOLBY PLII MUSIC), matrix mode (DOLBY PLII MATRIX), and Pro Logic mode (DOLBY PRO LOGIC):

DOLBY PLII MOVIE

The movie mode is the improved counterpart to the original Pro Logic decoder. It is the choice for the majority of Dolby Surround encoded material.

DOLBY PLII MUSIC

The music mode is for use with unencoded stereo music recordings. The music mode features dimension and center width controls, see **PLII Control**, on page 53, to enhance the music surround experience.

DOLBY PLII MATRIX

The matrix mode is useful for monaural recordings.

DOLBY PRO LOGIC

The Dolby Pro Logic mode provides the same surround processing as the original Pro Logic and is best used with source content that is not of optimum quality.

**THX and
THX Surround EX
Modes**

THX

THX post processing can be added to Dolby Surround, Dolby Digital, and DTS encoded material, and includes the following algorithms:

- Re-Equalization takes the edginess or brightness out of your home cinema sound.
- Timbre Matching matches the tone of your front loudspeakers to your surround loudspeakers.
- Adaptive Decorrelation gives a stereo feel when your surround source is mono. Adaptive Decorrelation automatically switches off when the surround source is stereo.
- Bass Management Electronic Crossover allows you to use more compact, easier-to-place loudspeakers, while sending bass to a subwoofer system, improving frequency response, lowering distortion and increasing dynamic range.
- Bass Peak Level Manager protects the subwoofer from overloading due to the great amount of bass a 5.1 soundtrack delivers.
- Loudspeaker Position Time Synchronization lets you easily set up your system for an optimum listening position.

THX SURR EX

THX Surround EX is a process that decodes a back surround signal from the left and right surround channels on specially encoded Dolby Digital DVD movie releases. THX Surround EX uses all the processing included in the THX operating mode (see above). Your system must include one or two back/surround loudspeakers for THX Surround EX to operate.

Note

If the DVD has the proper encoding, the Showcase Processor will recognize THX Surround EX and automatically engage the signal. Many DVD discs include THX Surround EX information but do not encode it in a way that a surround processor can recognize.

DTS Neo:6 Modes

DTS Neo:6 provides up to six full-bandwidth channels of information from stereo encoded material. 7.1 and 6.1 systems will derive six channels from the signal while 5.1 systems will derive five channels from the signal. DTS Neo:6 includes two modes: DTS NEO:6 CINEMA for two channel matrixed movie material and DTS NEO:6 MUSIC for stereo encoded music material.

Krell Music Surround Modes

The Krell Music Surround Modes simulate different soundfield experiences when listening to music. The table below lists the modes and the speakers that operate within each mode:

Table 6 Krell Music Surround Modes for the Showcase Processor

Operating Modes	Active Loudspeakers
GENERAL ADMISSION	L/R/S/RR
FRONT ROW	L/R/S/RR
ON STAGE	L/R/C/S/RR
ENHANCED STEREO	L/R/C/S
ORCHESTRA	L/R/C/S/RR
MEZZANINE	L/R/C/S/RR
FULL RANGE + SUB	L/R/C/S/RR
MONOPHONIC	C/S
PARTY	L/R/C/S/RR

Warranty

To register your product for warranty benefits, please complete and return the Warranty Registration Card enclosed in the shipping box within 15 days of purchase. Thank you.

This Krell product has a limited warranty of five years for parts and labor on circuitry. Should this product fail to perform at any time during the warranty, Krell will repair it at no cost to the owner, except as set forth in this warranty.

The warranty does not apply to damage caused by acts of God or nature.

The warranty on this page shall be in lieu of any other warranty, expressed or implied, including, but not limited to, any implied warranty of merchantability or fitness for a particular purpose. There are no warranties which exceed beyond those described in this document. If this product does not perform as warranted herein, the owner's sole remedy shall be repair. In no event will Krell be liable for incidental or consequential damages arising from purchase, use, or inability to use this product, even if Krell has been advised of the possibility of such damages.

Proof of purchase in the form of a bill of sale or receipted invoice substantiating that the unit is within the warranty period must be presented to obtain warranty service. The warranty begins on the date of the original retail purchase, as noted on the bill of sale or receipted invoice from an authorized Krell dealer or distributor. Previously owned equipment, when re-purchased from an authorized Krell dealer or distributor, has the balance of the original warranty, based on the original date of manufacture.

The warranty for Krell products is valid only in the country to which they were originally shipped, through the authorized Krell distributor for that country, and at the factory. There may be restrictions on or changes to Krell's warranty because of regulations within a specific country. Please check with your distributor for a complete understanding of the warranty in your country.

If a unit is serviced by a distributor who did not import the unit, there may be a charge for service, even if the product is within the warranty period.

Freight to the factory is your responsibility. Return freight within the United States (U.S.A.) is included in the warranty. If you purchased your Krell product outside the U.S.A. and wish to have it serviced at the factory, all freight and associated charges to the factory are your responsibility. Krell will pay return freight to the U.S.A.-based freight forwarder of your choice. Freight and other charges to ship the unit from the freight forwarder to you are also your responsibility.

Krell is not responsible for any damage incurred in transit. Krell will file claims for damages as necessary for units damaged in transit to the factory. You are responsible for filing claims for shipping damages during the return shipment.

Krell does not supply replacement parts and/or products to the owner of the unit. Replacement parts and/or products will be furnished only to the distributor performing service on this unit on an exchange basis only; any parts and/or products returned to Krell for exchange become the property of Krell.

No expressed or implied warranty is made for any Krell product damaged by accident, abuse, misuse, natural or personal disaster, or unauthorized modification.

Any unauthorized voltage conversion, disassembly, component replacement, perforation of chassis, updates, or modifications performed to the unit will void the warranty.

The operating voltage of this unit is determined by the factory and can only be changed by an authorized Krell distributor or at the factory. The voltage for this product in the U.S.A. cannot be changed until six months from the original purchase date.

In the event that Krell receives a product for warranty service that has been modified in any way without Krell authorization, all warranties on that product will be void. The product will be returned to original factory layout specifications at the owner's expense before it is repaired. All repairs required after the product has been returned to original factory specifications will be charged to the customer, at current parts and labor rates.

All operational features, functions, and specifications and policies are subject to change without notification.

Return Authorization Procedure

HOW TO EXPEDITE SERVICE

If you believe there is a problem with your component, please contact your dealer, distributor, or the Krell factory to discuss the problem *before* you return the component for repair. To expedite service, you may wish to complete and e-mail the Service Request Form in the Service section of our website at:

<http://www.krellonline.com>

To contact the Krell Service Department:

TEL	203-799-9954 Monday-Friday, 9:00 AM to 5:00 PM EST
FAX	203-799-9796
E-MAIL	service@krellonline.com
WEB SITE	http://www.krellonline.com

HOW TO RETURN A PRODUCT

To return a product to Krell, please follow this procedure so that we may serve you better:

1. Obtain a Return Authorization Number (R/A number) and shipping address from the Krell Service Department.
2. Insure and accept all liability for loss or damage to the product during shipment to the Krell factory and ensure all freight (shipping) charges are prepaid.

The product may also be hand delivered if arrangements with the Service Department have been made in advance. Proof of purchase will be required for warranty validation at the time of hand delivery.

IMPORTANT

Use the original packaging to ensure the safe transit of the product to the factory, dealer, or distributor. Krell may, at its discretion, return a product in new packaging and bill the owner for such packaging if the product received by Krell was boxed in nonstandard packaging or if the original packaging was so damaged that it was unuseable. If Krell determines that new packaging is required, the owner will be notified before the product is returned.

HOW TO PURCHASE ADDITIONAL PACKING

To purchase additional packaging, please contact your authorized Krell dealer, distributor, or the Krell Service Department for assistance.

SERIAL NUMBER

Your Showcase Processor product serial number is:

Specifications

SIGNAL-TO-NOISE RATIO	"A" WEIGHTED	94 dB
TOTAL HARMONIC DISTORTION (THD)	UNWEIGHTED	20 Hz-20 kHz, -88 dB
INPUTS	ANALOG AUDIO	1 pair balanced via XLR connectors 7 pairs single-ended via RCA connectors one 7.1 via RCA connectors
	DIGITAL AUDIO	4 coaxial via RCA connectors 4 EIAJ optical via TosLink connectors
	VIDEO	4 S-video via DIN connectors 4 composite via RCA connectors 3 component via RCA connector
	ANALOG TAPE	2 pair single-ended via RCA connectors
OUTPUTS	ANALOG CHANNEL (one per channel)	8 balanced via XLR connectors 8 single-ended via RCA connectors
	ANALOG TAPE	1 pair single-ended via RCA connectors
	DIGITAL	1 coaxial via RCA connector 1 EIAJ optical via TosLink connectors
	VIDEO	2 S-video via DIN connector, 1 with OSD 2 composite via RCA connectors, 1 with OSD 1 component via RCA connectors with OSD
REMOTE	REMOTE CONTROL	1 infrared
	REMOTE CONNECTORS	1 RS-232 1 RC-5 input 4 12 VDC OUT (12 V trigger) 1 12 VDC IN (12 V trigger)
DECODING MODES		Dolby Pro Logic II Dolby Digital 5.1 Dolby Digital EX DTS 5.1 DTS ES Discrete 6.1 DTS ES Matrix 6.1 THX Surround EX DTS Neo:6

Specifications, continued

SURROUND ENHANCEMENT MODES	KRELL MUSIC SURROUND	General Admission Front Row On Stage Enhanced Stereo Orchestra Mezzanine Full Range + Sub Monophonic Party
POWER CONSUMPTION		35 W
DIMENSIONS	INCHES	17.25w x 5.65h x 16.45d
	CENTIMETERS	43.82w x 14.35h x 41.78d
WEIGHT	SHIPPING	25 lb. 11.3 kg
	UNIT ONLY	19.25 lb. 8.75 kg

All operational features, functions, specifications, and policies are subject to change without notification.

Krell Industries, Inc.
45 Connair Road
Orange, CT 06477-3650 USA

TEL 203-799-9954
FAX 203-891-2028
E-MAIL krell@krellonline.com
WEBSITE <http://www.krellonline.com>

Showcase Processor

Surround

Preamp/Processor

v 02.3